

Digital Tachometer

Digital Tachometer/ Elapsed timecounter/ Time width meter/ Flowmeter

Standard input series Differential input series

DT-501X/DT-501F

Instruction Manual



Thank you for purchasing SHIMPO's Digital Tachometer DT-501X/DT-501F. For instructions on how to use this product properly and optimally for a long period of time, please be sure to read this manual thoroughly before use.

When you purchase the product with optional equipment: Please refer to the operation manual of the optional equipment.

Before operation, maintenance and inspection, please carefully read this instruction manual and follow it for proper use.

After reading, be sure to store this manual in a safe, convenient place where operators can always refer to it easily.

Safety Requirements

Be sure to observe

Before operation, maintenance and inspection, please carefully read this instruction manual and follow it for proper use. Please carefully read all information related to this unit and safety, and precautions before use.

This instruction manual categorizes safety precautions as "DANGER", "WARNING", and "CAUTION". Each of them is an important description related to safety. Be sure to observe.

 **DANGER**

Improper use by neglecting the following precautions may result in the potential for fire, serious injuries, and/or death.

 **WARNING**

Improper use may result in serious injuries.

 **CAUTION**

Improper use may result in minor injuries or property damage.

ⓧ Limited Warranty

- ⓧ We are not responsible for damages resulting from negligence through failure to follow the instructions set out in this manual.
- ⓧ We are not responsible for damages resulting from earthquake and/or fire unrelated to us, actions by third parties, or any other accidents, intentional or through customer negligence, as well as from accidents caused by misuse or improper use under abnormal conditions.
- ⓧ For information regarding assurance provisions, please read the attached warranty certificate.

 **CAUTION**

 **Electric Shock.**
Be sure to turn the power OFF when wiring as well as inspecting the unit.
 Failure to do so could result in electric shock.

 **DO NOT block the ventilation holes on the side of the main unit. DO NOT put any foreign objects or materials inside the unit through these holes.**
 Failure to follow this could result in abnormal heat generation and/or malfunctions.

 **DO NOT touch the unit with wet (or sweaty) hands when inspecting or for wiring.**
 Failure to do this could result in electric shock.

 **Precautions before use**

Power
 ⓧ Be sure to use the unit under the specified voltage (AC power specifications: 85 - 264VAC / DC power specifications: 10.8 - 25.2VDC).
 ⓧ Inverter power source cannot be used.

Input signal wire
 ⓧ Connection wiring from sensors shall not be kept in the same or parallel conduit or cable as the power source, power or high voltage cables. If you fail to separate the wiring, noise may be superimposed on the signal wire, resulting in malfunctions.
 ⓧ Use shielded wire for input power connections with the shortest possible metal conduit.

Terminal
 ⓧ Check that the screws have not come loose due to vibrations after a certain period of time.

Operating environment
 ⓧ Do not install the unit in the following places or conditions.
 ⓧ ⓧ Places exposed to direct sunlight, or places where the ambient temperature exceeds a range of 0 - 45°C.
 ⓧ ⓧ Places where the relative humidity percentage exceeds a range of 35 - 85%, or places subject to condensation due to rapid change in humidity.
 ⓧ ⓧ Places subject to corrosive and/or combustible gases.
 ⓧ ⓧ Places subject to a large amount of dust, salinity, and/or ferric substance.
 ⓧ ⓧ Places susceptible to noise (including static electricity).

INDEX

1. Installation to the Start of Operation	2
2. Unit Model	2
3. Specifications	3
4. Component Part Names and Functions	3
5. External Dimensions	4
6. Installation to the Panel	4
7. Wiring to Power Source and Sensors (DT-501XA/DT-501XD)	5
8. Wiring to Power Source and Sensors (DT-501FA)	6
9. Basic Setting Procedure	6
10. Keys to be Used for Various Settings and Their Applications	6
11. Teaching Function Settings	7
12. About Mode	8
13. When You Select Mode 1 (Digital Tachometer Mode) for Measurement	8
14. When You Select Mode 2 (Elapsed Timecounter Mode) for Measurement	10
15. When You Select Mode 3 (Time Width Meter Mode) for Measurement	12
16. When You Select Mode 4 (Flowmeter Mode) for Measurement	14
17. Setting Method of Functions (Excluding in the Test Mode, Common in Each Mode)	16
18. Comparator Function	17
19. Memory Function	18
20. Test Mode (Function to Check if the Unit is Operating Normally)	19
21. Error Display	19
22. Parameter List	20
23. Function List	21
24. Option -FVT/-FVC	23
25. Option -BCD	25
26. Option -TRT	27
27. Option -CPT	27
28. DT-501X / DT-501F series model list	28

1. Installation to the Start of Operation

This unit is designed for use according to your measurement purposes.
Before use, follow the procedures below from installation to the start of operation.

Check before use

Check before use	p.2 - 4
------------------	---------

- Unit model
- Specifications
- Component part names and functions
- External dimensions

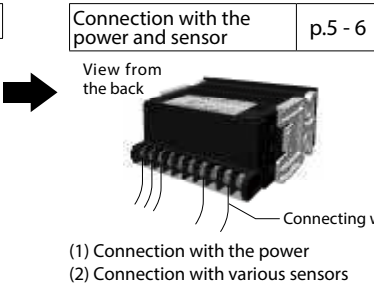
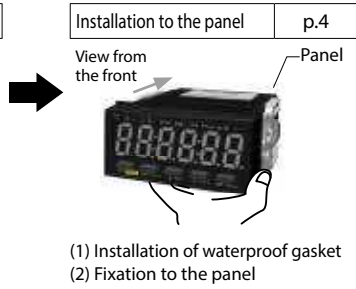

Memory function settings	p.17 - 19
--------------------------	-----------

- (1) Press the MEM key once to display the MAX value.
- (2) Press the MEM key again to display the MIN value.
- (3) Press the MEM key once again to display the normal measurement value.

*You can use the unit without setting various functions.

Function (action configuration) settings	p.8 p.16-17
--	----------------

- (1) Press and hold the SHIFT + FUNC keys for 5 seconds or more and start setting.
- (2) Press the ▲ key to select the item, and press the ENT key to start changing the setting value.
- (3) Press the ► key to move to another digit, and after changing the value using the ▲ key, use the ENT key to finish the setting value change.
- (4) After setting all functions, use the SET key to finish setting.

Parameter settings	p.8 - 15
--------------------	----------

- (1) Press and hold the SHIFT + PAR keys for 5 seconds or more and start setting.
- (2) Press the ▲ key to select the item, and press the ENT key to start changing the setting value.
- (3) Press the ► key to move to another digit, and after changing the value using the ◻ key, use the ENT key to finish the setting value change.
- (3) After setting all parameters, use the SET key to finish setting.

Mode (function) settings	p.8 - 15
--------------------------	----------

- (1) Press the SHIFT + MOD keys and start setting.
- (2) Use the ▲ key to set, and use the SET key to finish setting.

Start of operation

Teaching function settings P7

◻Parameter settings are not necessary.

2. Unit Model

Please check the model number of the equipment purchased.

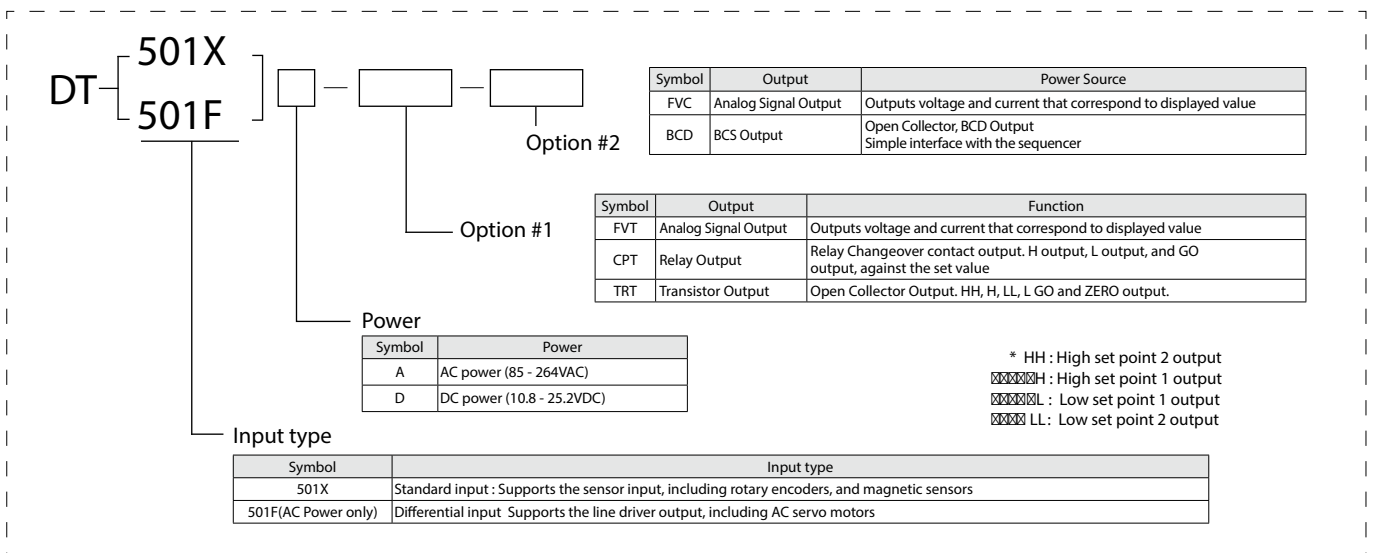

3. Specifications

Unit model		DT-501X DT-501F			
Display	Action mode	Digital tachometer mode	Flowmeter mode	Elapsed timecounter mode	Time width meter mode
	Display 1	0 - 999999 6 digits		0:00:00 - 9:59:59 (Hour:Minute:Second / base 60 display)	0:00:00 - 0:59:59 (Hour:Minute:Second / base 60 display)
	Display 2	-		0:00 - 999:99 (Hour:Minute:Second / base 10 display)	
		With zero suppression function			
Decimal point position	0 to 5 digits after the decimal point(000000 0.00000)			-	
Number indicator	Red 7 segment LED, Letter height 22mm, 6 digits, - display available				
LED lamp	8 (SIG, LL, L, H, HH, MAX, MIN, TEA)				
Operation key	5 SET/SHIFT, MEM/TEACH, UP/PARA, NEXT/FUNC, ENT/MODE				
Input range	0.0067Hz 100kHz			10ms - 3600s	
Measurement accuracy	±0.008 ±1digit			±0.1 ±1 digit	
Filter	Switches between 100kHz, 30kHz, 10kHz, and 0.02kHz using the parameter. Note that you can switch between only 10kHz and 0.02kHz in a magnetic sensor, and its contact is only 0.02kHz.				
Display cycle	0.2, 0.5, 1, 2, 5, 10, 15, 30, 60 sec. (changeable in the parameter settings)			Dependent on the input signal	
Pre-scale function	Parameter setting system using the front panel keys. The teaching (combination) of display values are also available.				
Memory function	The maximum/minimum measurement values can be memorized and displayed in the indicator. (Switches the display using the MEM key)				
Comparator function	The settings of the high set point 1, low set point 1, high set point 2, and low set point 2, and judgment results can be displayed on the LED lamp. The hysteresis setting of the high and low set point 1 values are also available.				
Auto zero time	0.1 - 150 sec.			0.1 - 3600 sec.	
Pre-arithmetic function	Updates the displayed value according to the elapsed time after the pulse stops.				
Teaching function	Performs scaling automatically by setting the display value with a certain signal input. (only in the tachometer and flowmeter modes)				
Insulation resistance	10MΩ or more (at DC500V Mega)				
Voltage proof	AC1500V or more 1min				
Operating temperature	0 - 45°C(No condensation)				
Operating humidity	35 - 85%RH (No condensation)				
Operating atmosphere	No corrosive gas				
Conforming standard	RoHS				
Protection function	Front panel: IP66 (or equivalent), Rear terminal block: IP20				
Casing material	ABS resin				
External dimensions	96 × 48 × 92 (DIN)				
Weight	Approx. 200g FVT FVC TRT BDC options : + approx. 50g CPT options : + approx. 100g				

*There are the input specifications in addition to the above specifications. For details, refer to p.5 - 6.

4. Component Part Names and Functions

Front



Rear

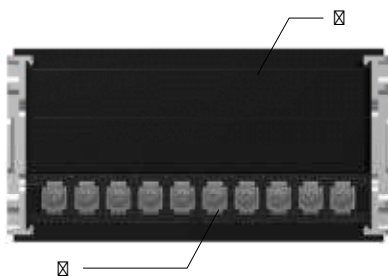

Side

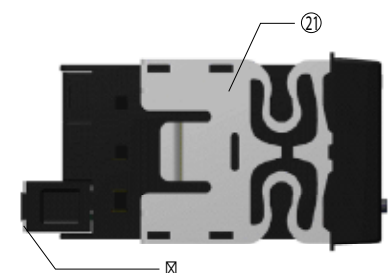

N°	Name	Function
1	SIG lamp	Lights up when the sensor signal is input
2	LL lamp	Lights up when the low set point 2 is judged.
3	L lamp	Lights up when the low set point 1 is judged.
4	H lamp	Lights up when the high set point 1 is judged.
5	HH lamp	Lights up when the high set point 2 is judged.
6	MAX amp	Lights up when the maximum value is displayed
7	MIN lamp	Lights up when the minimum value is displayed
8	TEA lamp	Lights up when the teaching function is set
9	PEAK lamp	Not used
10	BTM lamp	Not used
11	Unit label space	Space for attaching the supplied unit labels
12	Main display	Displays the measurement value
13	SET/SHIFT key	Finishes the setting in various setting modes Pressing this key with other keys switches to various setting modes
14	MEM/TEACH key	Switches to the memory display Pressing this key with the SET key goes to the teaching setting mode
15	UP/PARA key	Changes the selected items in various setting modes, or numerical values Pressing this key with the SET key switches to the parameter setting mode
16	NEXT/FUNC key	Changes the selected digit in various setting modes Pressing this key with the SET key switches to the function setting mode
17	ENT/MODE key	Selects the changed item(s) in various setting modes Pressing this key with the SET key switches to the mode setting mode
18	Terminal block	
19	Rear panel	
20	Terminal block cover	
21	Mounting adapter	

Unit label

PS	ℓ _h	cm _{min}	h	PS	ℓ _h	cm _{min}	h	FVT
								CPT
	kHz	rpm	ℓ _{min}		kHz	rpm	ℓ _{min}	TRT
								FVC
sec	min	rps	Hz	h:m:s	sec	min	rps	Hz
								TRC
	m _h	mm _s	ℓ _s	r _{min}	m _h	mm _s	ℓ _s	r _{min}
								BCD
								RMT
								DRT
	m _{min}	km _h	mm _{min}		m _{min}	km _h	mm _{min}	SDT
								SDC

5. External Dimensions

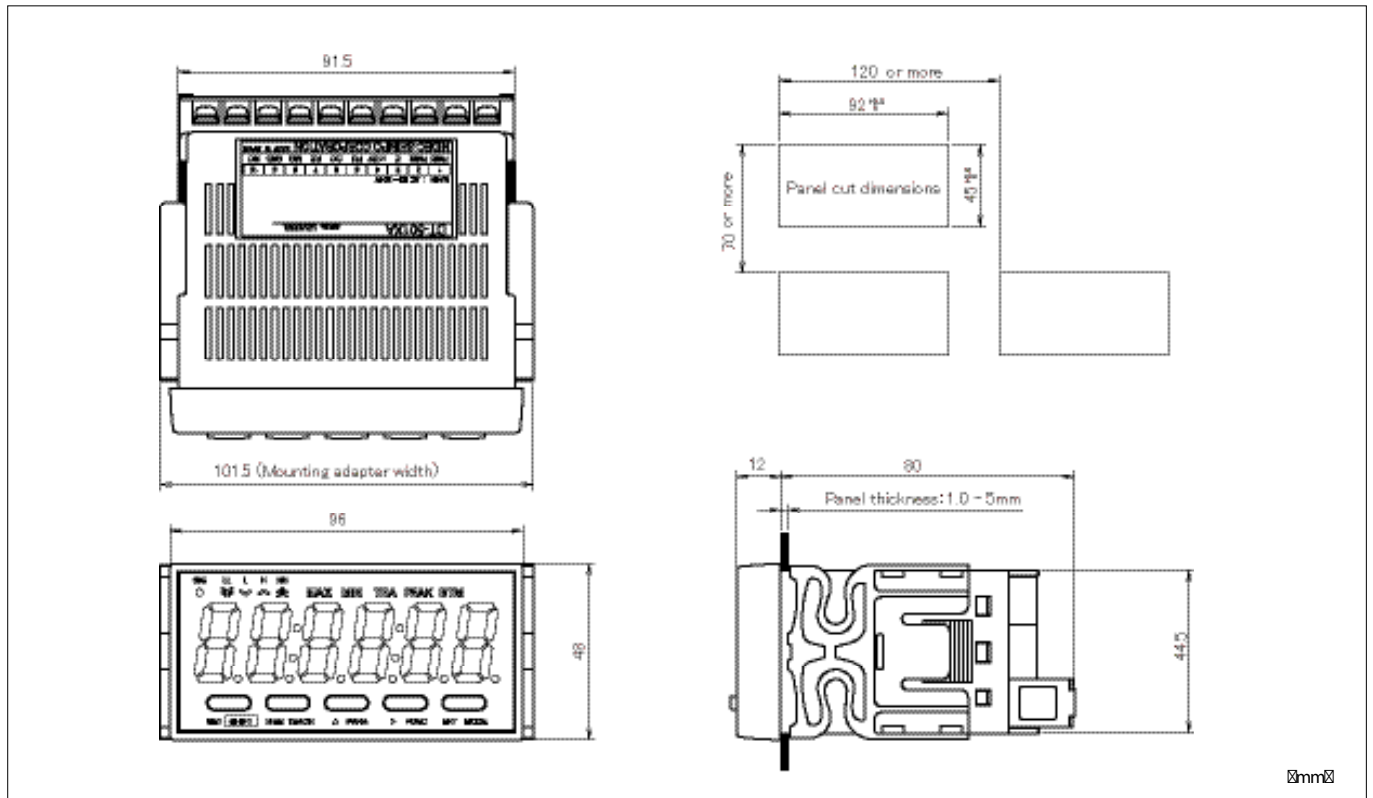

6. Installation to the Panel

Mount this unit to the panel according to the following procedures.
Check that the mounting panel is thick enough (1.0 - 5mm) before mounting operation.

1 Attach the provided waterproof gasket to the panel surface.

* If waterproofing is not necessary, skip this step.

- (1) Remove the external frame with the cutting lines (backing paper + waterproof gasket) from the gasket sheet.
(Adhesive paste is applied on the both sides of the waterproof gasket.)

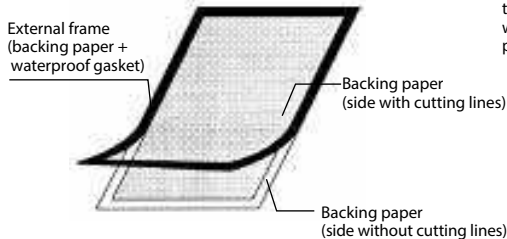

- (2) Attach the provided waterproof gasket to the edges of the unit attachment panel and opening, aligning with its left and right sides, and then peel off the backing paper.
* At this time, be sure not to displace or wrinkle the waterproof gasket. Also, do not expand the waterproof gasket vertically and/or horizontally past the attachment panel's edges.

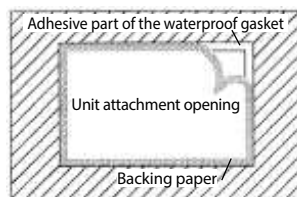

CAUTION

- About waterproofing
- ☒ Front panel: IP66 (or equivalent)
 - ☒ Rear terminal block: IP20 (non-waterproof)
- Do not install the unit in the following places or conditions.
- (1) Places regularly subject directly to water
 - (2) Places subject to oil splashes and/or medical supplies
 - (3) Places subject to water splashes on the rear or side face(s).
- * The front panel is IP66 (or equivalent) waterproofed, but if water is splashed on the unit, be sure to wipe it off the unit as soon as possible.

2 Place the unit horizontally, and insert the gasket into the opening of the panel surface. Push the unit until the waterproof gasket (adhesive part) securely reaches the panel surface of the unit.

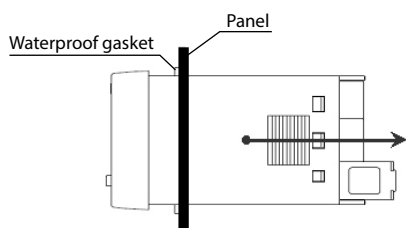

3 Attach the mounting adapter to the unit. Slide the mounting adapter until it lightly touches the panel surface.

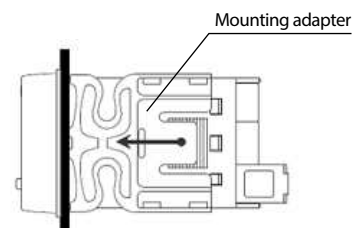

7. Wiring to Power Source and Sensors (DT-501XA/DT-501XD)

Note)

In order to prevent electric shock, be sure to turn the power OFF. Be sure to use the unit under the rated voltage (AC power specifications: 85 - 264VAC / DC power specifications: 10.8 - 25.2VDC). The inverter output (output to connect a motor) cannot be used as power. Connection wiring from sensors shall not be kept in the same or parallel conduit or cable as the power source, power or high voltage cables. If you fail to separate the wiring, noise may be superimposed on the signal wire, resulting in malfunctions. Use shielded wire for input power connections with the shortest possible metal conduit.

For DT-501XA/DT-501XD

• Terminal block connection diagram

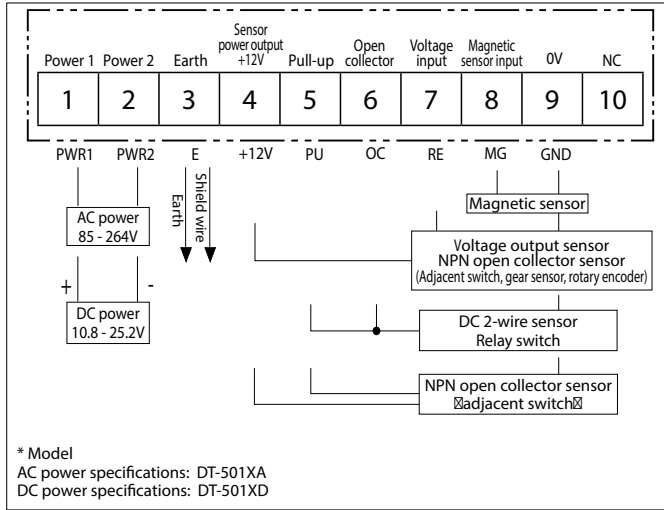

☒ Wiring requirements

- ☒ Use M3 crimp-style terminals with a width of 7 mm or less to connect wires to the terminal block.
- ☒ After wire connection to the terminal block is completed, be sure to attach the provided terminal block cover.

⚠ CAUTION

Be sure to connect the power wires to the 1st and 2nd terminals. Incorrect connection could result in damage and/or burns to the unit.

• Input specifications

Item	Description		
Power	AC (DT-501XA)	85 - 264VAC(50/60Hz)	
	DC (DT-501XD)	10.8 - 25.2VDC	
Consumption power	10VA		
Sensor power output	DC+12V Max.100mA		
Open collector input	Open collector (NPN) input		
	LO input	Load capacity 12mA or more	
	HI input	Leakage current 0.5mA or less	
	Maximum frequency	100kHz(Minimum pulse width 5micro second)	
Contact input	For no-voltage contact. Short-circuit ☒ and ☒ to use.		
	Contact capacity	Voltage 12V, Current 15mA or more	
	Maximum frequency	20Hz(Minimum pulse width 25micro second)	
Voltage input	LO input	0 - 1.5V	
	HI input	4.0 - 30V	
	Input resistance	10kΩ	
	Maximum frequency	30kHz(Minimum pulse width 17micro second)	
Magnetic sensor input	Input resistance	10kΩ	
	Input voltage	1Hz ☒ 100Hz	0.3 ☒ 30Vp-p
		☒ 1kHz	1.5 ☒ 30Vp-p
		☒ 10kHz	6 ☒ 30Vp-p
	Maximum frequency	10kHz(Minimum pulse width 50micro second)	

Note) Magnetic sensors cannot be used in the time wide meter mode (mode 3).

• Connection list with sensors

The table below shows the sensors and connection terminal No. to be applied according to the input signal type. Check using the connection diagram on the left.

Input signal type	Sensor	Our product model	Connection terminal
Contact signal	Relay switch	☒	5-6-9
Open collector	Adjacent switch	SE-P12-1	4-6-9
	Rotary encoder	RE-1-☒F	4-7-9
Square wave	Gear sensor	SE-G2	

Note 1)

Connect sensor wires to the specified terminals, and be sure to leave the other terminals empty. More than one sensor cannot be connected simultaneously.

Note 2)

When one sensor is connected to more than one tachometer, supply the power for the sensor from one of them.

• Input circuit

Open collector sensor

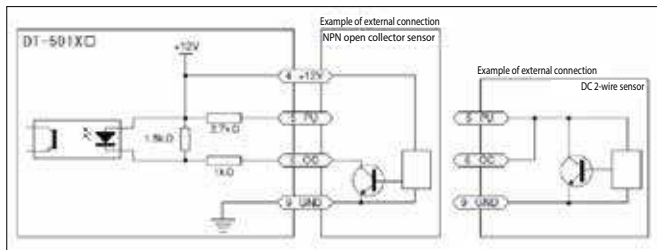

Voltage output sensor

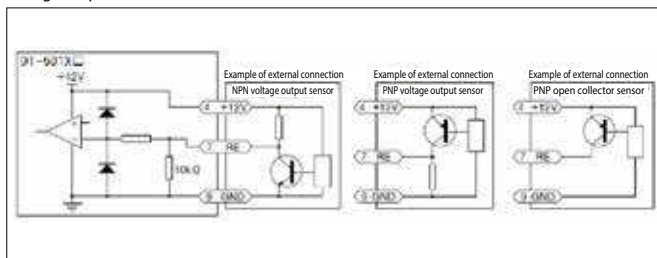

Relay switch

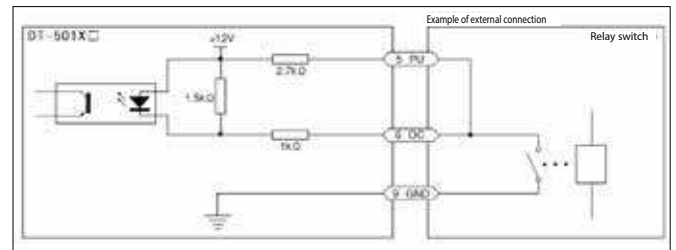

Magnetic sensor

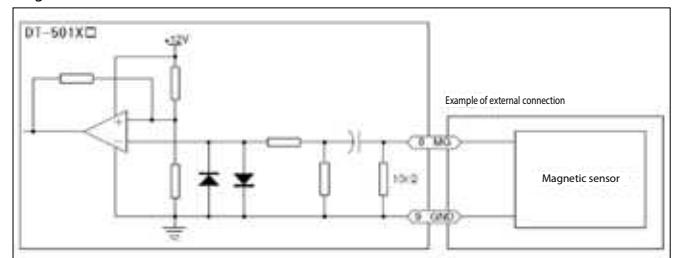

8. Wiring to Power Source and Sensors (DT-501FA)

Note)

In order to prevent electric shock, be sure to turn the power OFF. Be sure to use the unit under the rated voltage (AC power specifications: 85 - 264VAC). The inverter output (output to connect a motor) cannot be used as power. Connection wiring from sensors shall not be kept in the same or parallel conduit or cable as the power source, power or high voltage cables. If you fail to separate the wiring, noise may be superimposed on the signal wire, resulting in malfunctions. Use shielded wire for input power connections with the shortest possible metal conduit.

For DT-501FA

Terminal block connection diagram

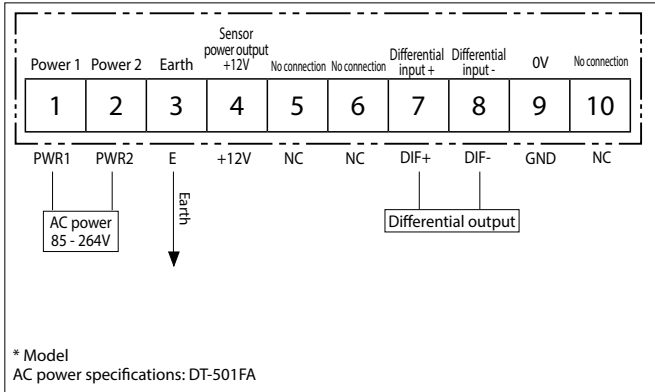

Wiring requirements

- ☒ Use M3 crimp-style terminals with a width of 7 mm or less to connect wires to the terminal block.
- ☒ After wire connection to the terminal block is completed, be sure to attach the provided terminal block cover.

CAUTION

Be sure to connect the power wires to the 1st and 2nd terminals. Incorrect connection could result in damage and/or burns to the unit.

Line driver input circuit

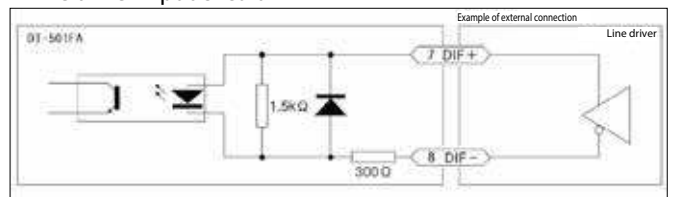

Terminal block connection diagram

Item	Description		
Power	AC (501FA)	85 - 264VAC(50/60Hz)	
Consumption power	10VA		
Sensor power output	DC+12V Max.100mA		
Differential input	Connection to	Differential line driver AM26LS31 etc.	
	Differential input voltage		
		Maximum voltage	±5.5V(15mA)
		Minimum voltage	±3.0V
Maximum frequency	100kHz(Minimum pulse width 5micro second)		

9. Basic Setting Procedure

Conduct settings as indicated below based on the intended use.

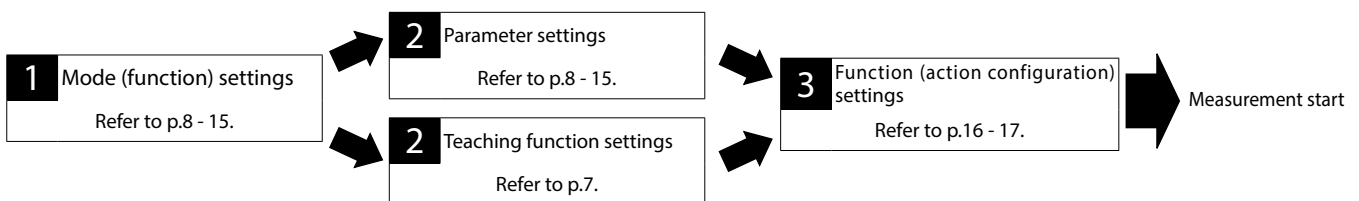

Conduct the comparator function → p.17 and memory function settings → p.18, if necessary.

This unit requires no complicated calculation, and implements the teaching function which enables optional changes of display values and error compensation. (excluding the elapsed timecounter and time wide meter modes)

10. Keys to be Used for Various Settings and Their Applications

The front panel keys to be used for mode, parameter, and function settings, as well as various settings (teaching function / high and low set point 1 value setting / memory function) are described below.



Operation during the normal measurement display / memory display

Nº	Name	Function
☒	SHIFT key	Pressing this key with other keys switches to various setting modes
☒	MEM key	Switches to the memory display
☒	TEACH key	Pressing and holding this key with the SHIFT key for 5 seconds switches to the teaching setting mode
☒	PARA key	Pressing and holding this key with the SHIFT key for 5 seconds switches to the parameter setting mode
☒	FUNC key	Pressing and holding with the SHIFT key for 5 seconds switches to the function setting mode
☒	MODE key	Pressing and holding this key with the SHIFT key for 5 seconds switches to the parameter setting mode

Operation in the various setting modes

Nº	Name	Function
☒	SET key	Setting completion key in various setting modes
☒	▲(UP) key	Changes the selected items in various setting modes, or numerical values
☒	▶(EXT) key	Changes the selected digit in various setting modes
☒	ENT key	Selects the changed item in various setting modes

12. About Mode

DT-501X/DT-501F have five modes (functions) which can be selected according to the measurement purpose.

Mode No.	Mode description	Details	Page No. for the setting method
1	Digital Tachometer Mode*	Digital tachometer / used as speedmeter. Displays the proportional value to the input	p.8 - 9
2	Elapsed Timecounter Mode	Used as the elapsed time display in a certain period. Displays the inversely proportional value to the input	p.10 - 11
3	Time Width Meter Mode	Measures time for the period when the signal is ON (or OFF) and displays it	p.12 - 13
4	Flowmeter Mode	Displays the instantaneous flow amount	p.14 - 15
99	Test Mode	Executes the self diagnosis	p.19

*The mode 1 (digital tachometer mode) is set in the factory setting.



For the lists of parameters and functions to be set in each mode, refer to pages 20 and 21.

13. Setting Method when You Select Mode 1 (Digital Tachometer Mode) for Measurement

Digital tachometer mode

Set each setting item for mode and parameter according to the following procedures.
(For the setting method of functions, refer to pages 16 and 17.)

Setting example (for measuring the peripheral speed of the roller)

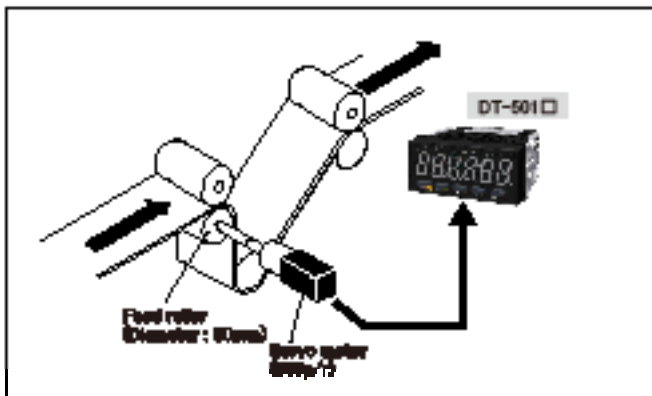

As in the figure on the left, the rotary encoder is connected to the feed roller via coupling in the paper manufacturing process. To display the peripheral speed (m/min.) of the feed roller in DT-501 under the following conditions:

[Conditions]

- Servo motor (pulse input)
- Diameter of the feed roller
- Peripheral speed of the roller diameter of 90mm
- $0.09\text{m} \times 3.14 \times 500\text{rpm} = 141.3\text{m/min}$
- Circumference of the roller
- Revolution speed*

*Suppose that the revolution speed in the detection section is 500rpm because the revolution speed is not instructed.

Setting method

(1) Mode

When you select mode 1 (digital tachometer mode) for measurement (The digital tachometer mode is set in the factory setting.)

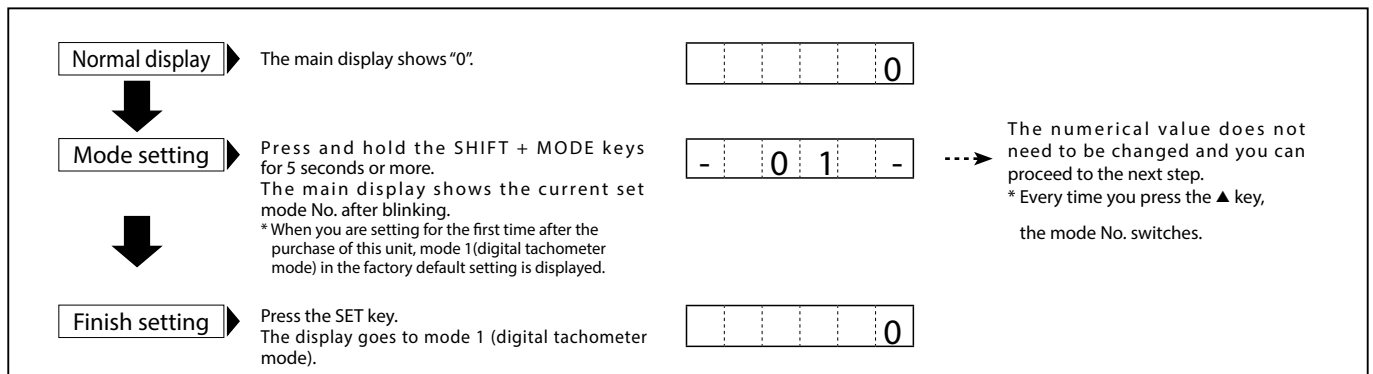

Note) If you change the mode settings, each parameter and function setting value will return to the factory default setting value.

(2) Parameter

Parameter setting items in mode 1 (digital tachometer mode) and numerical values to be set according to the above example

No.	Setting item	Setting range	Default setting value		Numerical value to be set according to the above example	
			Display	Description		
P1	Pulse count per revolution	1 - 9999p/r	__0001	1p/r	600p/r	Enter the pulse count of the rotary encoder.
P2	Revolution speed in the detection section	1 - 99999rpm	_01000	1000rpm	500rpm	Enter some numerical value as the revolution speed is not instructed.
P3	Value to be displayed (with decimal point)	0.00001 - 999999	001000	1000	141.3	Refer to the above "Setting example".
P4	Display cycle	0.2/0.5/1.0/2.0/5.0/10/15/30/60 sec.	_ 1.0 _	1 sec.	1 sec.	Measure using the default setting value as no special instruction is provided.
P5	Auto zero time	0.1 - 150 sec.	_ _ 006.0	6.0 sec.	6 sec.	Measure using the default setting value as no special instruction is provided.
P6	Input filter	10/30/100/0.02kHz	_ 10 _	10kHz	30kHz	As the rotary encoder is used as a sensor, select "30".

* For the description about the parameter functions, refer to page 20.

☒ Mode 1 (digital tachometer mode) Display value calculation equation

Mode 1 Display value calculation			
External input pulse (Hz)			A
Parameter setting	P1	Pulse count per revolution	B
	P2	Revolution speed in the detection section(rpm)	C
	P3	Value to be displayed	D
Equation	$\frac{A}{B} \times 60 \times (D/C)$		

• Start setting according to the setting example on the previous page.

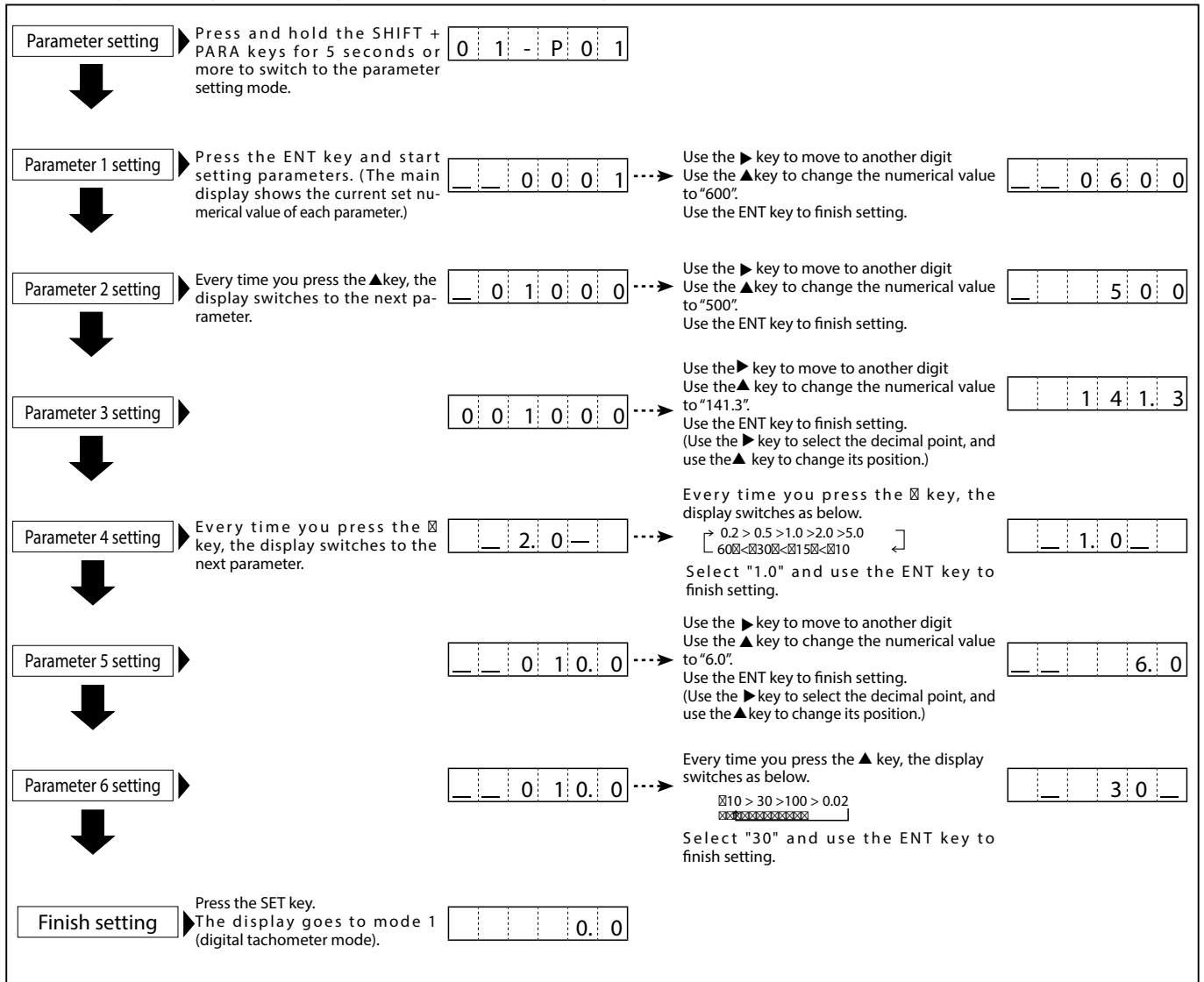

*If you enter a value outside the setting range, all the input values will blink, which indicates the setting is disabled.

☒When this occurs, you cannot switch to other displays until you enter a value within the setting range.

(3) Function (For the setting method, refer to pages 16 and 17.)

• Function setting item in mode 1 (digital tachometer mode)

No.	Setting item	Setting range	Input range	Default value
F1	High set point 1 value	Sets the high set point 1 value	000000 - 999999	0
F2	Low set point 1 value	Sets the high set point 1 value	000000 - 999999	0
F3	High set point 2 value	Sets the high set point 2 value	000000 - 999999	0
F4	Low set point 2 value	Sets the low set point 2 value	000000 - 999999	0
F5	Hysteresis of the high and low set point 1 values	Sets the hysteresis of the high and low set point 1 values	0 - 99	0
F6	Judgment output timer at startup	Sets the time when the comparator judgment is output at startup	0 - 99 sec.	0 sec.
F7	Minimum revolution speed	Sets the revolution speed to be displayed as zero	000000 - 999999	0
F8	Frequency of the moving average	Used when variation of the revolution speed is large and a stable display cannot be attained	0(disabled)/1(3 times)/2(10 times)	0(disabled)
F9	Pre-arithmetic function	Promptly performs the deceleration display when the signal is lost	0(disabled)/1(enabled)	0(disabled)

* For the description of functions, refer to pages 21 and 22.

Set each setting item for mode and parameter according to the following procedures.
(For the setting method of functions, refer to pages 16 and 17.)

☒ Setting example (for the elapsed time display of oven)

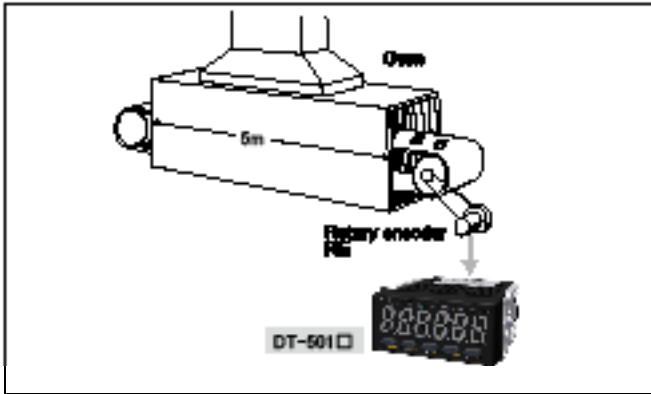

As in the figure on the left, bread passes through the oven in a bread factory. The rotary encoder is attached to the motor of the conveyor belt. To display the time at which the bread passes through the oven in DT-501, do so under the following conditions:

- [Conditions]
- ☒ Revolution speed of the rotary encoder ☒ 1200rpm (rotary encoder 60p/r)
 - ☒ Speed of the conveyor belt ☒ 2.8m/min
 - ☒ Length of the oven ☒ 5m
 - ☒ Passing time through the oven ☒ 5m ÷ 2.8m/min ☒ 1.786 minutes ☒ Approx. 1 minute 47 seconds

• Setting method

(1) Mode

• Set the mode 2 (elapsed timecounter mode).

Normal display ▶ The main display shows "0".

↓

Mode setting ▶ Press and hold the **[SHIFT] + [MODE]** keys for 5 seconds or more. The main display shows the current set mode No. after blinking.

↓

Finish setting ▶ Press the **SET** key. The display goes to mode 2 (elapsed timecounter mode).

_ _ _ _ 0

- 0 1 -

→

_ 2 _ _

Every time you press the ▲ key, the display switches to the next mode No.

1 2 3 4

↑

99

←

Select "2".

- 0 2 -

Note) If you change the mode settings, each parameter, function, and high and low set point 1 setting value will return to the factory default setting value.

(2) Parameter

• Parameter setting items in mode 2 (elapsed timecounter mode) and numerical values to be set according to the above example.

No.	Setting item		Setting range	Default setting value		Numerical value to be set according to the above example	
				Display	Description		
P1	Pulse count per revolution		1 - 9999p/r	_ _ 0001	1p/r	60p/r	Enter the pulse count of the rotary encoder.
P2	Revolution speed in the detection section		1000 - 99999rpm	_ 01000	1000rpm	1200rpm	Enter the revolution speed of the rotary encoder.
P3	Value to be displayed	Hour:Minute:Second display system	0:00:01 - 9:59:59	_ 010:00	10:00 sec.	Hour:Minute:Second display system	Refer to the above "Setting example".
		Second display system	0:01 - 999:99			0:01:47	
P4	Display cycle		0.2/0.5/1.0/2.0/5.0/10/15/30/60 sec.	_ 1.0 _	1 sec.	1 sec.	Measure using the default setting value as no special instruction is provided.
P5	Auto zero time		0.1 - 150 sec.	_ _ 006.0	6.0 sec.	6 sec.	Measure using the default setting value as no special instruction is provided.
P6	Input filter		10/30/100/0.02kHz	_ 10 _	10kHz	30kHz	As the rotary encoder is used as a sensor, select "30".

* For the description about the parameter functions, refer to page 20.

☒ Mode 2 (elapsed timecounter mode) Display value calculation equation

Mode 2 Display value calculation			
External input pulse (Hz)			A
Parameter setting	P1	Pulse count per revolution	B
	P2	Revolution speed in the detection section(rpm)	C
	P3	Value to be displayed	D
Equation	$\frac{A}{60} \div \left(\frac{B}{C} \times 60 \right) \times D$		

☒ Start setting according to the setting example on the previous page.

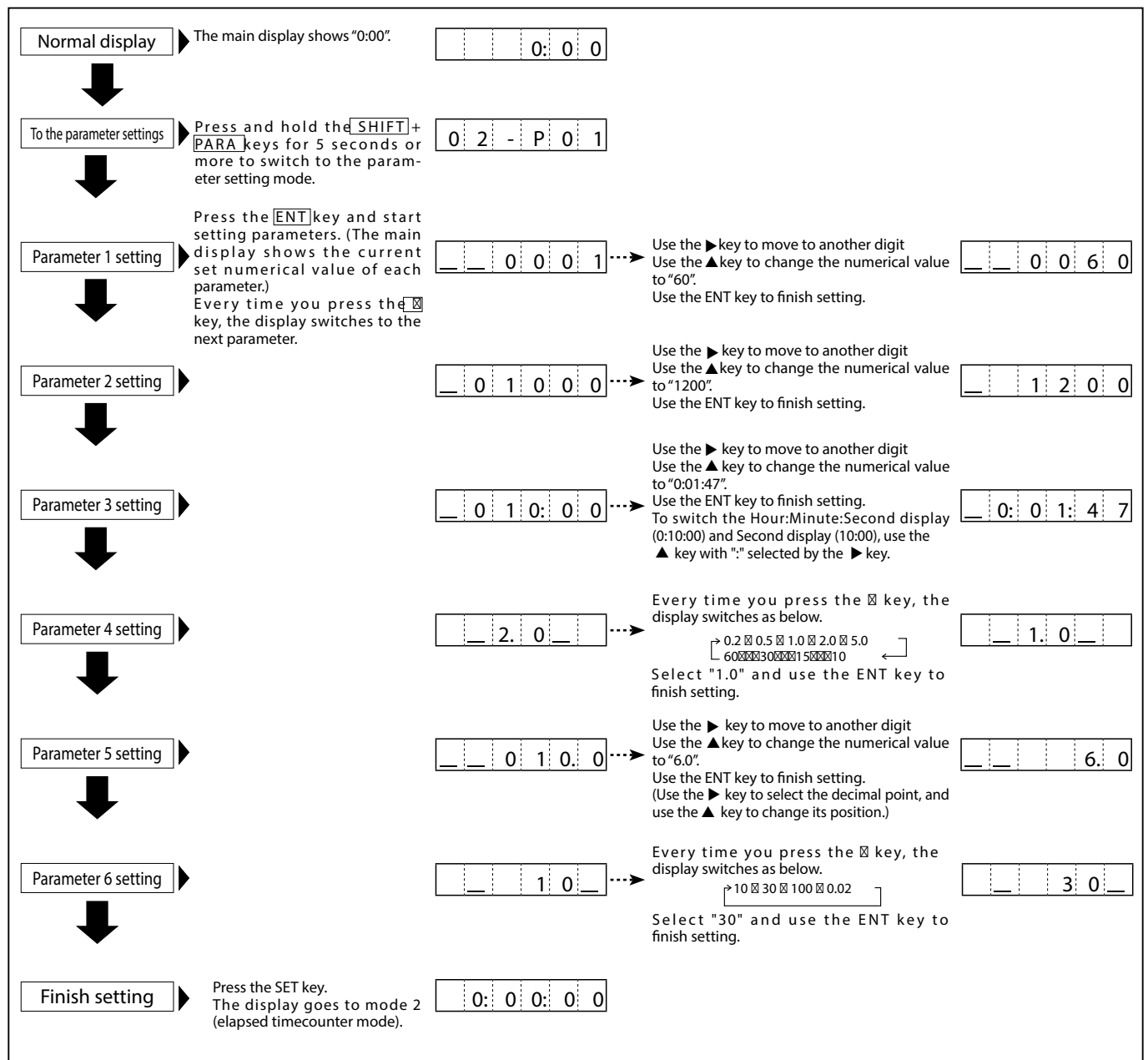

*If you enter a value outside the setting range, all the input values will blink, which indicates the setting is disabled.
 ☒ When this occurs, you cannot switch to other displays until you enter a value within the setting range.

(3) Function (For the setting method, refer to pages 16 and 17.)

• Function setting item in mode 2 (elapsed timecounter mode)

No.	Setting item	Description	Input range	Default setting
F1	High set point 1 value	Sets the high set point 1 value (Hour:Minute:Second display system)	0:00:00 - 9:59:59	Second display system
		Sets the high set point 1 value (Second display system)	0:00 - 999:99	0:00
F2	Low set point 1 value	Sets the low set point 1 value (Hour:Minute:Second display system)	0:00:00 - 9:59:59	Second display
		Sets the low set point 1 value (Second display system)	0:00 - 999:99	0:00
F3	High set point 2 value	Sets the high set point 2 value (Hour:Minute:Second display system)	0:00:00 - 9:59:59	Second display
		Sets the high set point 2 value (Second display system)	0:00 - 999:99	0:00
F4	Low set point 2 value	Sets the low set point 2 value (Hour:Minute:Second display system)	0:00:00 - 9:59:59	Second display
		Sets the low set point 2 value (Second display system)	0:00 - 999:99	0:00
F5	Hysteresis of the high and low set point 1 values	Sets the hysteresis of the high and low set point 1 values	0 - 99	0
F6	Judgment output timer at startup	Sets the time when the comparator judgment is output at startup	0 - 99 sec.	0 sec.
F7	Minimum revolution speed	Sets the revolution speed to be displayed as zero	000000 - 999999	0
F8	Frequency of the moving average	Used when variation of the revolution speed is large and a stable display cannot be attained	0(disabled)/1(3 times)/2(10 times)	0(disabled)
F9	Pre-arithmetic function	Promptly performs the deceleration display when the signal is lost	0(disabled)/1(enabled)	0(disabled)

* For the description of functions, refer to page 21.

Note) When the input signal stops in the elapsed timecounter mode, the display will overflow after the specified time set with the auto zero function. The overflow display "-----" does not mean there is a malfunction. When the input signal is within the display range, the display returns to normal.

Set each setting item for mode and parameter according to the following procedures.
 (For the setting method of functions, refer to pages 16 and 17.)

☒ Setting example (for the operating time display of the press machine)

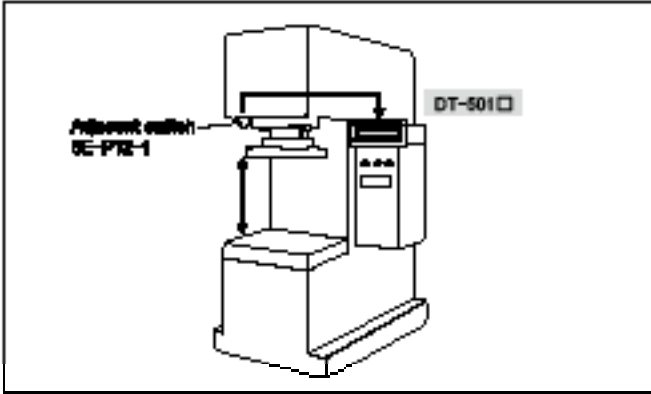

As in the figure on the left, when the press machine finishes operation and returns to the upper edge, the adjacent switch is activated. To display the operating time of the press machine (when the proximity switch is turned off)

☒ Setting method

(1) Mode

• Set mode 3 (Time Width Meter Mode).

Normal display → The main display shows "0".

↓

Mode setting → Press and hold the SHIFT + MODE keys for 5 seconds or more. The main display shows the current set mode No. after blinking.
 * When you are setting for the first time after the purchase of this unit, mode 1 (digital tachometer mode) in the factory default setting is displayed.

↓

Finish setting → Press the SET key. The display goes to mode 3 (time wide meter mode).

0

→

- 0: 1 -

0: 0: 0

→

Every time you press the ▲ key, the display switches to the next mode No.

1 2 3 4
↑ 99 ↓

Select "3".

Note) If you change the mode settings, each parameter, function, and high and low set point 1 setting value will return to the factory default setting value.

(2) Parameter

• Parameter setting items in mode 3 (Time Width Meter Mode) and numerical values to be set according to the above example.

No.	Setting item	Setting range	Default setting value		Numerical value to be set according to the above example	
			Display	Description		
P1	Switch between Hour:Minute:Second and 1/100 Second system	0:00:00/0:00	0:00	1/100 sec.	0:00	Select the 1/100 second display based on the operating time of the press machine.
P2	Measurement section	0(OFF)/1(ON)	_ 1 _	ON	0	Select "0" because the adjacent switch of the open collector is OFF.
P3	Auto zero time	0.1 - 3600 sec.	_3600.0	3600 sec.	60.0 sec.	Set "60.0" because there is no time setting longer than 1 minute.
P4	Input filter	10/0.02kHz	_ 10 _	10kHz	10kHz	Measure using the default setting value as no special instruction is provided.

* For the description about the parameter functions, refer to page 20.

☒ About the measurement section (parameter 2)

Relay switch, open collector, DC 2-wire sensor
 ON (When the No.6 terminal is at L level)

Voltage pulse
 ON (When the No.7 terminal is at H level)

12

• Start setting according to the setting example on the previous page.

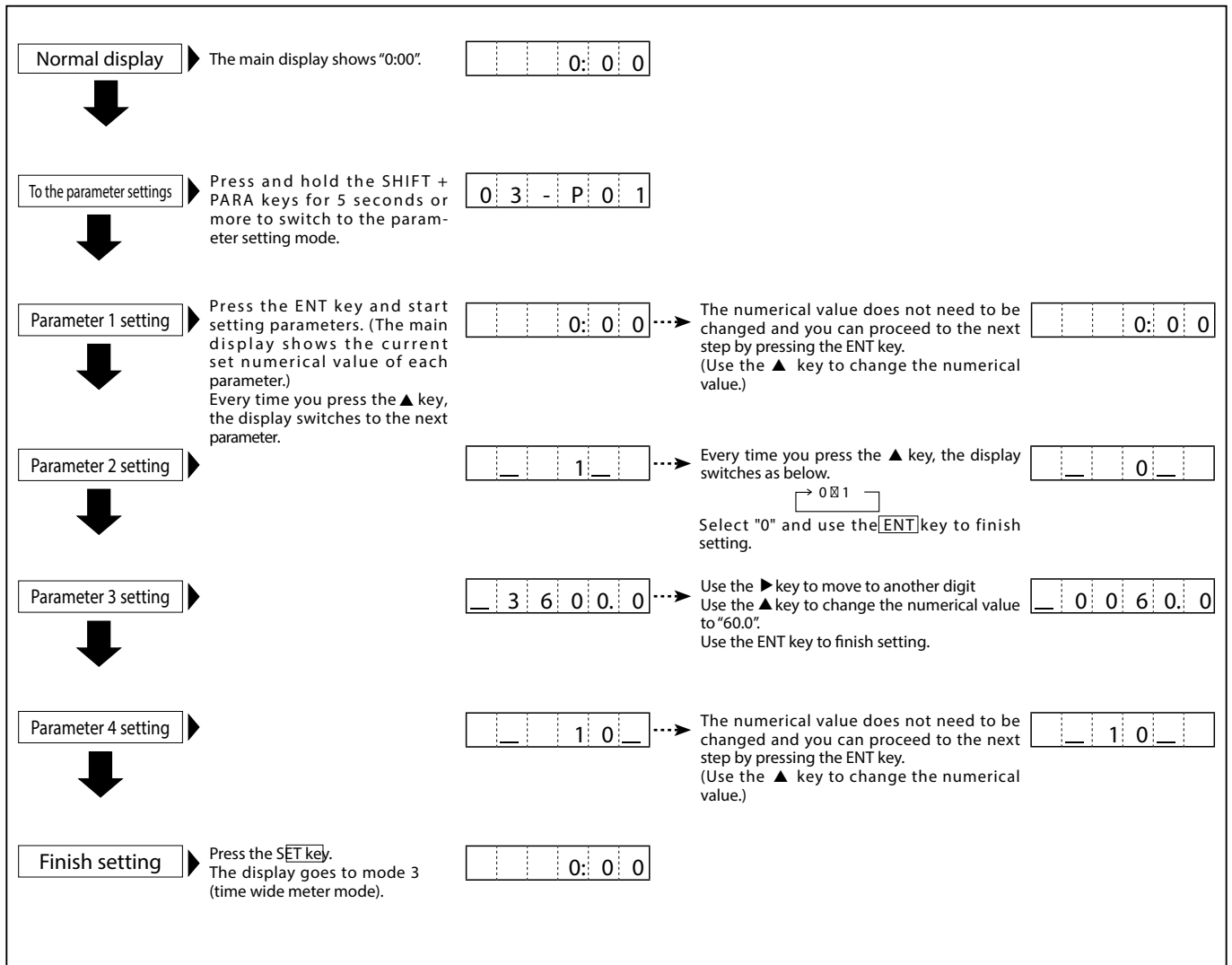

*If you enter a value outside the setting range, all the input values will blink, which indicates the setting is disabled.
 ☒When this occurs, you cannot switch to other displays until you enter a value within the setting range.

(3) Function (For the setting method, refer to pages 16 and 17.)
 Function setting item in mode 3 (Time Width Meter Mode)

No.	Setting item	Description	Input range	Default setting
F1	High set point 1 value	Sets the high set point 1 value (Hour:Minute:Second display system)	0:00:00 - 9:59:59	Second display system 0:00
		Sets the high set point 1 value (Second display system)	0:00 - 999:99	
F2	Low set point 1 value	Sets the low set point 1 value (Hour:Minute:Second display system)	0:00:00 - 9:59:59	Second display system 0:00
		Sets the low set point 1 value (Second display system)	0:00 - 999:99	
F3	High set point 2 value	Sets the high set point 2 value (Hour:Minute:Second display system)	0:00:00 - 9:59:59	Second display system 0:00
		Sets the high set point 2 value (Second display system)	0:00 - 999:99	
F4	Low set point 2 value	Sets the low set point 2 value (Hour:Minute:Second display system)	0:00:00 - 9:59:59	Second display system 0:00
		Sets the low set point 2 value (Second display system)	0:00 - 999:99	
F5	Hysteresis of the high and low set point 1 values	Sets the hysteresis of the high and low set point 1 values	0 - 99	0
F6	Judgment output timer at startup	Sets the time when the comparator judgment is output at startup	0 - 99 sec.	0 sec.

* For the description of functions, refer to pages 21 and 22.

Set each setting item for mode and parameter according to the following procedures.
(For the setting method of functions, refer to pages 16 and 17.)

☒ Setting example (For the flow display from the tank)

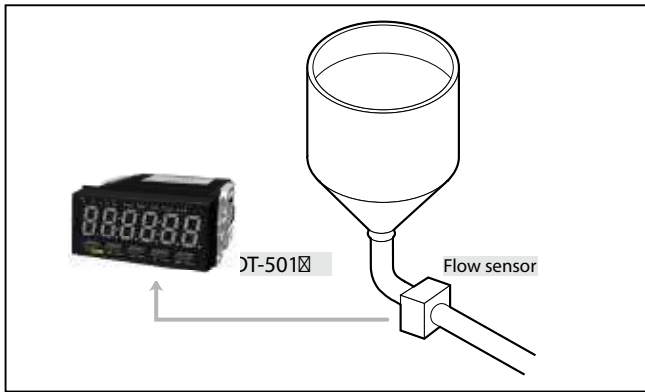

To display the flow (ℓ/min) in DT-501 under the following conditions when the flowmeter for which the number of blades is unknown as in the figure on the left:

- [Conditions]
 ☒ Number of blades : Unknown
 ☒ Output of the flow sensor : 2.5cc/p *p : Pulse

☒ Setting method

(1) Mode

• Set mode 4 (flowmeter mode).

Normal display ▶ The main display shows "0". _ _ _ _ 0

↓

Mode setting ▶ Press and hold the SHIFT + MODE keys for 5 seconds or more. The main display shows the current set mode No. after blinking.
 * When you are setting for the first time after the purchase of this unit, mode 1 (digital tachometer mode) in the factory default setting is displayed. - 0 1 -

↓

Finish setting ▶ Press the SET key. The display goes to mode 4 (flowmeter mode). _ _ _ _ 0.0

Every time you press the ▲ key, the display switches to the next mode No.

1 2 3 4
_ 99 _

Select "4": - 0 4 -

Note) If you change the mode settings, each parameter, function, and high and low set point 1 setting value will return to the factory default setting value.

(2) Parameter

• Parameter setting items in mode 4 (flowmeter mode) and numerical values to be set according to the above example.

No.	Setting item	Setting range	Default setting value		Numerical value to be set according to the above example	
			Display	Description		
P1	Number of blades per revolution	1 - 99	__ _ 01	1	1	Enter the number of blades of the flowmeter. If it is unknown, enter "1".
P2	Capacity per sensor blade (cc, ℓ, etc.)	0.0001 - 99999	_ 0001.0	1.0	2.5cc/p	Enter the capacity per blade that the sensor can read.
P3	Scaling	0.00000 - 999999	00001.0	1	0.06	Refer to "About scaling" below.
P4	Decimal point display	0.00000 - 00000.0	00000.0	Displays to one decimal place	00000.0	Displays to one decimal place.
P5	Display cycle	0.2/0.5/1.0/2.0/5.0/10/15/30/60 sec.	_ 1.0_	1 sec.	1 sec.	Measure using the default setting value as no special instruction is provided.
P6	Auto zero time	0.1 - 150 sec.	_ _ 006.0	6 sec.	6 sec.	Measure using the default setting value as no special instruction is provided.
P7	Input filter	10/30/100/0.02kHz	_ 10_	10kHz	10kHz	Measure using the default setting value as no special instruction is provided.

* For the description about the parameter functions, refer to page 20.

☒ Mode 4 (flowmeter mode) Display value calculation equation

Mode 4 Display value calculation		
External input pulse (Hz)		A
Parameter setting	P1 Number of blades per revolution	B
	P2 Capacity per sensor blade	C
	P3 Scaling	D
	P4 Decimal point display	E
Equation	(A * B) * C * D	

☒ About scaling (parameter 3)

Assuming the flow per second to be represented in the parameter 2 flow unit (cc in the example) is a (cc/s), parameter 3 will be coefficient value when a multiplier is used to change the unit of a (cc/s) for display.

(1) To display the value as in the original unit (cc/s)

$a \text{ (cc/s)} * 1 \text{ } \boxed{a} \text{ (cc/s)}$
 ☒ Parameter 3

(2) To display the value in the unit (ℓ/min) as in the above setting

$a \text{ (cc/s)} * 60 \div 1000 \text{ } \boxed{A} \text{ (ℓ/min)}$
 ☒ Parameter 3

* 60 : Multiply it by 60 as it is the flow per minute.
 ÷1000 : Divide the value by 1000 as parameter is set in the unit of "cc".

• Start setting according to the setting example on the previous page.

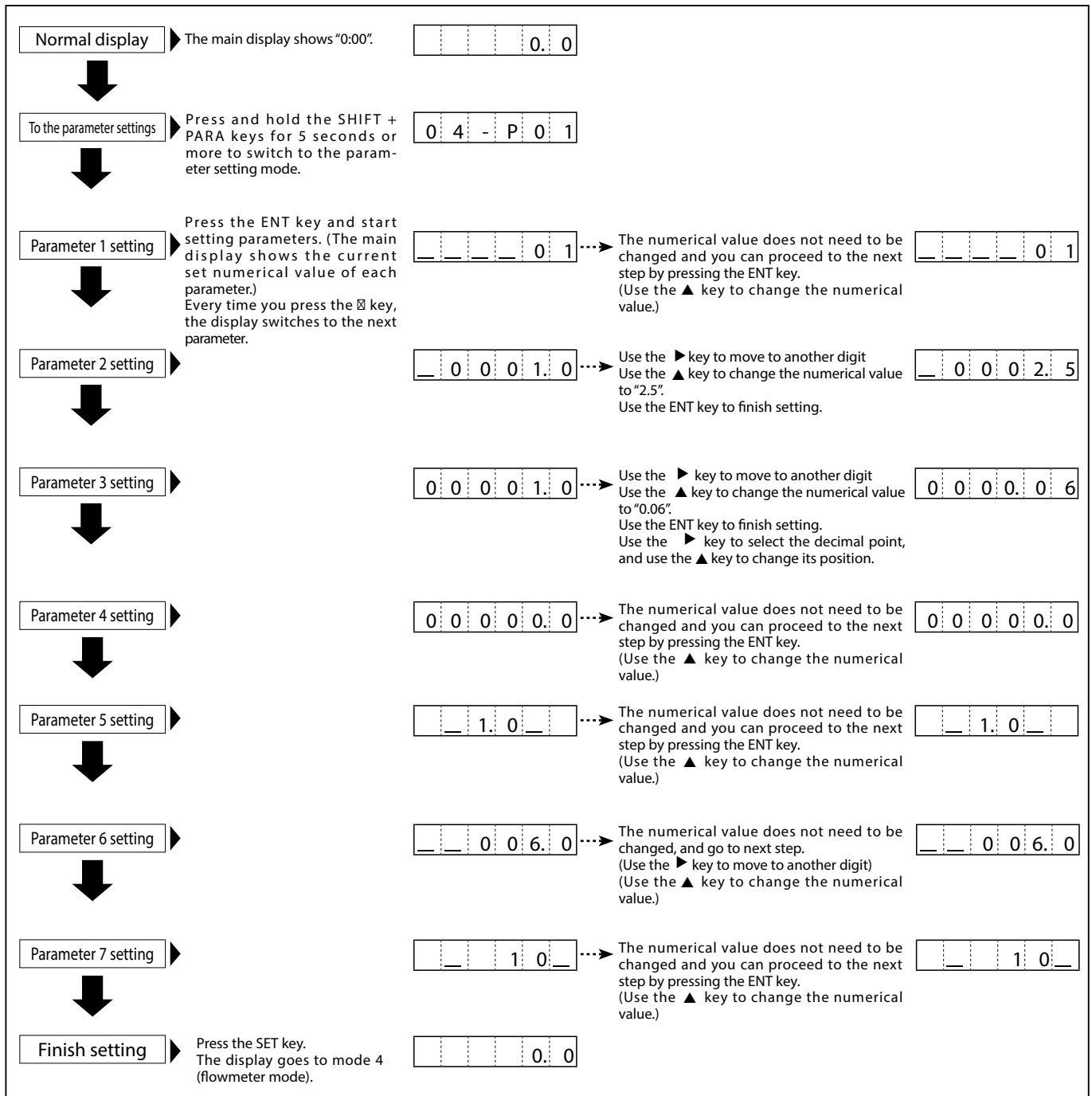

*If you enter a value outside the setting range, all the input values will blink, which indicates the setting is disabled.
 ☒When this occurs, you cannot switch to other displays until you enter a value within the setting range.

(3) Function (For the setting method, refer to pages 16 and 17.)

• Function setting item in mode 4 (flowmeter mode)

No.	Setting item	Description	Input range	Default setting
F1	High set point 1 value	Sets the high set point 1 value	000000 - 999999	0
F2	Low set point 1 value	Sets the high set point 1 value	000000 - 999999	0
F3	High set point 2 value	Sets the high set point 2 value	000000 - 999999	0
F4	Low set point 2 value	Sets the low set point 2 value	000000 - 999999	0
F5	Hysteresis of the high and low set point 1 values	Sets the hysteresis of the high and low set point 1 values	0 - 99	0
F6	Judgment output timer at startup	Sets the time when the comparator judgment is output at startup	0 - 99 sec.	0 sec.
F7	Minimum flow(display value)	Sets the revolution speed to be displayed as zero	000000 - 999999	0
F8	Frequency of the moving average	Used when variation of the revolution speed is large and a stable display cannot be attained	0(disabled)/1(3 times)/2(10 times)	0(disabled)
F9	Pre-arithmetic function	Promptly performs the deceleration display when the signal is lost	0(disabled)/1(enabled)	0(disabled)

* For the description of functions, refer to page 21.

17. Setting Method of Functions (Excluding in the Test Mode, Common in Each Mode)

The setting method of the functions is common in each mode excluding the test mode.
For the lists of functions in each mode, refer to page 21.

• Function setting item <in mode 1 (digital tachometer mode)>

No.	Setting item	Setting range	Default setting		Function description
			Display	Description	
F1	High set point 1 value*	000000 - 999999	000000	0	Sets the high set point 1 value. The decimal point is not displayed.
F2	Low set point 1 value*	000000 - 999999	000000	0	Sets the low set point 1 value. The decimal point is not displayed.
F3	High set point 2 value*	000000 - 999999	000000	0	Sets the high set point 2 value. The decimal point is not displayed.
F4	Low set point 2 value*	000000 - 999999	000000	0	Sets the low set point 2 value. The decimal point is not displayed.
F5	Hysteresis of the high and low set point 1 values	0 - 99	____00	0	Sets the hysteresis of the high and low set point 1 values. Used when the revolution variation is large. (For details, refer to "Comparator Function" on page 17.)
F6	Judgment output timer at startup	0 - 99 sec.	____00	0 sec.	Sets the time when the comparator judgment is output at startup
F7	Minimum revolution speed	000000 - 999999	000000	0	Sets the revolution speed to be displayed as zero
F8	Frequency of the moving average	0(disabled)/1(3 times)/2(10 times)	_ 0 _	0(disabled)	Used when variation of the revolution speed is large and a stable display cannot be attained
F9	Pre-arithmetic function	0(disabled)/1(enabled)	_ 0 _	0(disabled)	Promptly performs the deceleration display when the signal is lost

*For the settings of the high set point 1 and 2 values, as well as the low set point 1 and 2 values, refer to "Comparator Function" on page 17.

• Setting method <in mode 1 (digital tachometer mode)>

For the setting methods in other modes than mode 1 (digital tachometer mode), also refer to the description below.

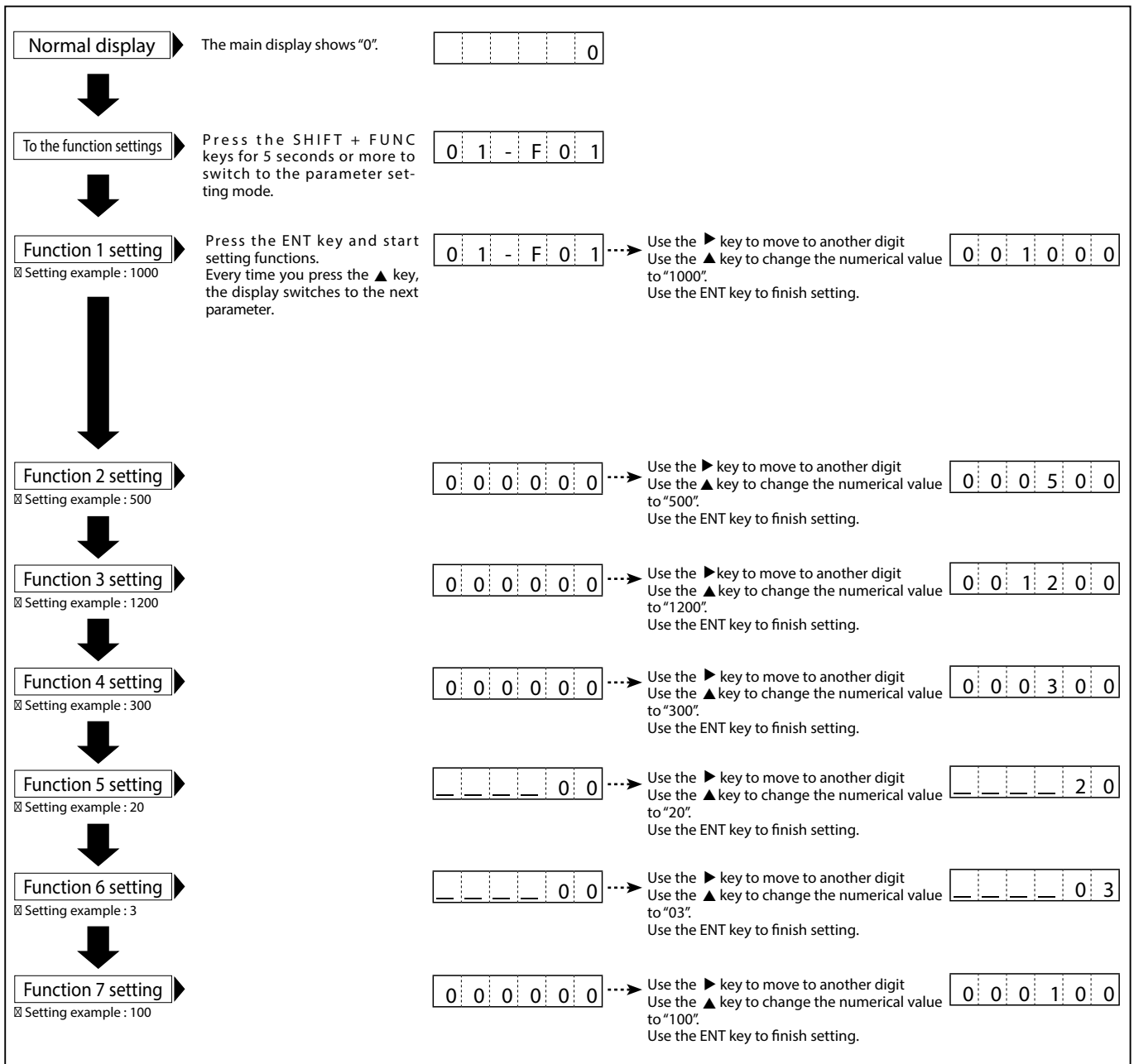

Continued on next page

Continued from previous page

Function 8 setting

☑ Setting example : 1

Every time you press the ▲ key, the display switches to the next function. Press the ENT key and start setting functions.



Every time you press the ▲ key, the display switches as below. Use the ENT key to finish setting.







Function 9 setting

☑ Setting example : 1

Every time you press the ▲ key, the display switches as below. Use the ENT key to finish setting.



Every time you press the ▲ key, the display switches as below. Use the ENT key to finish setting.





Finish setting

Press the SET key. The display goes to mode 1 (digital tachometer mode).

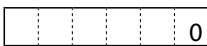

* If you enter a value outside the setting range, all the input values will blink, which indicates the setting is disabled.
 When you press any of the numerical input key, the numerical value before entry is displayed, and you can redo the setting.
 *When the relationship among the setting values of F1 to F4 is not appropriate, "EE-4" is displayed before finishing the function setting by pressing the SET key.
 For details, refer to page 19.

☑18. Comparator Function

• Keys to be used for the high and low set point 1 value settings and their applications



Judgment lamp

The corresponding lamp lights up according to the judgment result.		
	Name	Function
☑	LL lamp	Lights up when the low set point 2 is judged.
☑	L lamp	Lights up when the low set point 1 is judged.
☑	H lamp	Lights up when the high set point 1 is judged.
☑	HH lamp	Lights up when the high set point 2 is judged.

• Description

☑ Judgment conditions

Low set point 1 value ☑ Measurement value ☑ High set point 1 value AND Low set point 2 value ☑ Measurement value ☑ High set point 2 value	GO judgment
When either the high and low set point 1 value judgment or the high and low set point 2 value judgment is invalid, and the other is within the setting range	
Measurement value ☑ High set point 2 value	HH judgment
Measurement value ☑ High set point 1 value	H judgment
Measurement value ☑ Low set point 2 value	LL judgment
Measurement value ☑ Low set point 1 value	L judgment

- ☑ Set the high set point 1, low set point 1, high set point 2, and low set point 2 values using the function items F01 to F04.
- ☑ Execute the judgment in the all measurement mode.
- ☑ The high and low set point 2 value judgment, as well as the high and low set point 1 value judgment, is executed independently.
- ☑ When both the high set point 2 and low set point 2 values are "0", the high and low set point 2 value judgment is not executed.
- ☑ When both the high set point 1 and low set point 1 values are "0", the high and low set point 1 value judgment is not executed.
- ☑ When both the high set point 2 and low set point 2 values, as well as the high set point 1 and low set point 1 values are "0", no judgment is executed.

• About hysteresis

When hysteresis is set in function F5, provide hysteresis between the judgment ON and OFF.

The hysteresis setting value is common to the high set point 1, low set point 1, high set point 2, and low set point 2 value judgment.

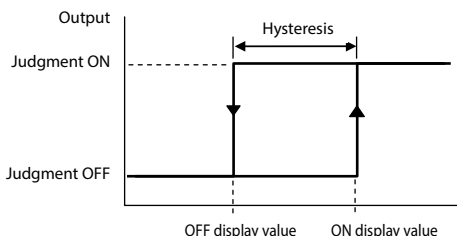

☑ Conditions under the high set point 1 and 2 value judgment

Judgment OFF > ON	Measurement value ☑ Judgment value
Judgment ON > OFF	Measurement value ☑ Judgment value - Hysteresis value

☑ Conditions under the low set point 1 and 2 value judgment

Judgment OFF > ON	Measurement value ☑ Judgment value
Judgment ON > OFF	Measurement value ☑ Judgment value + Hysteresis value

19. Memory Function

- Key to be used for the memory function and display

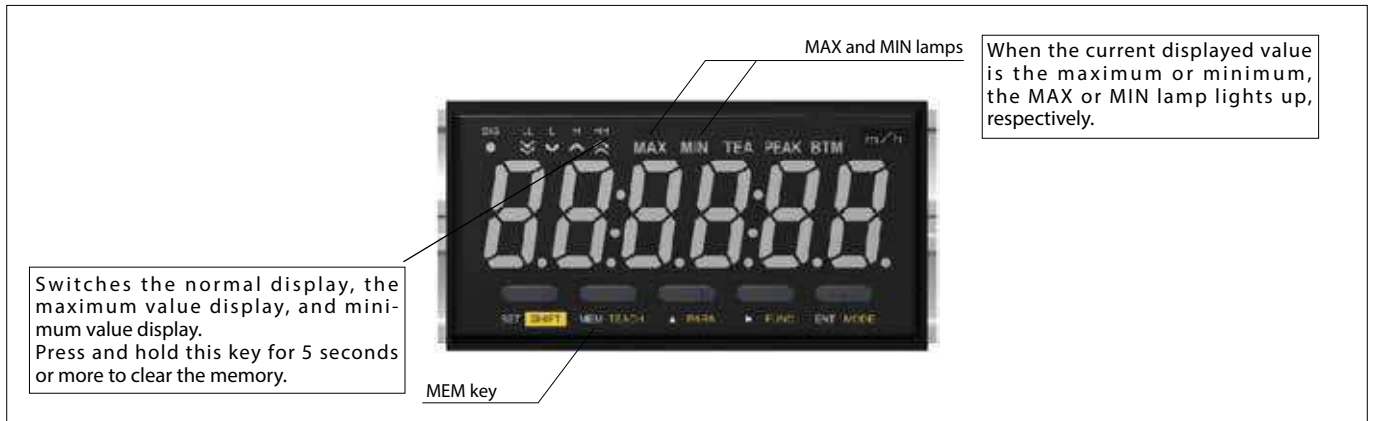

- During measurement, the maximum display value (MAX value) and minimum display value (MIN value) per display update cycle is always maintained.
- Pressing the MEM key allows you to check the maximum and minimum values maintained during the measurement.

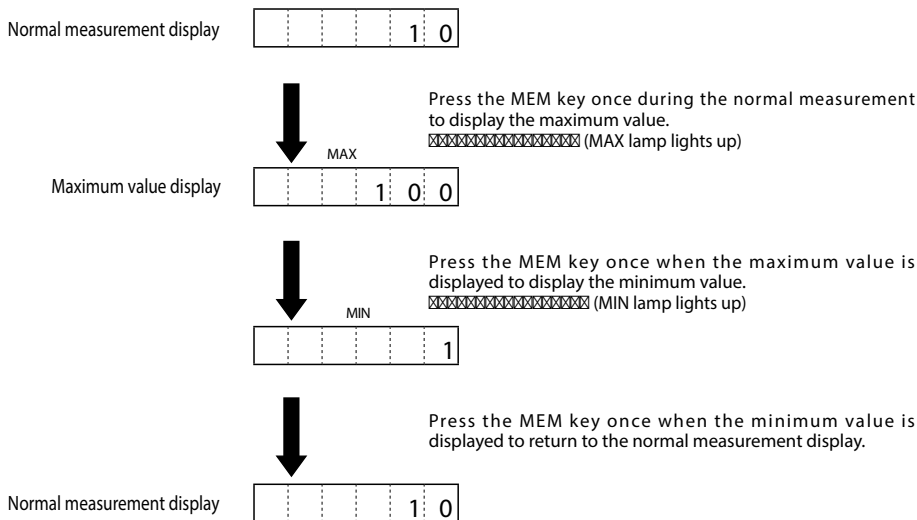

- Press and hold the MEM key for 5 seconds during the normal measurement and memory display. Clears the maintained MAX and MIN values.

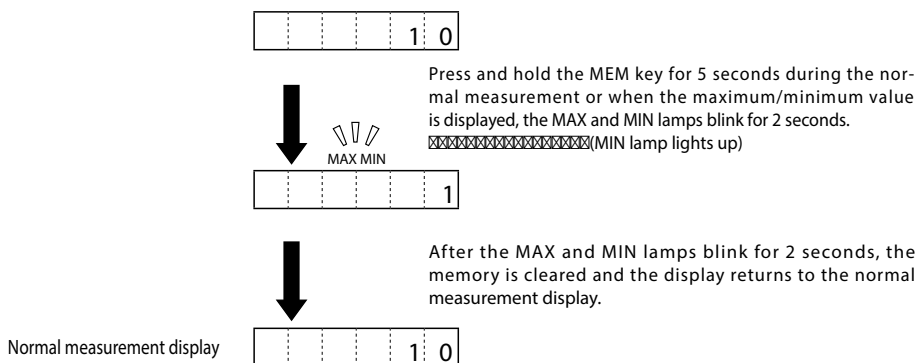

- As in the figure below, the maintained values are cleared when the measurement is reset (when the mode and setting value are changed, and the power is turned ON).

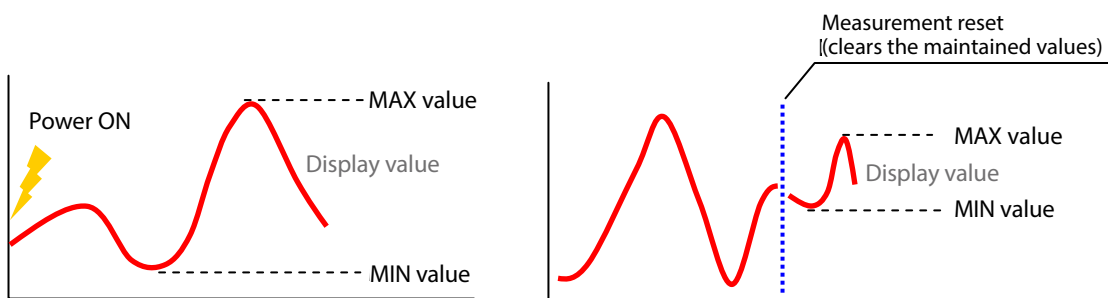

20. Test Mode (Function to Check if the Unit is Operating Normally)

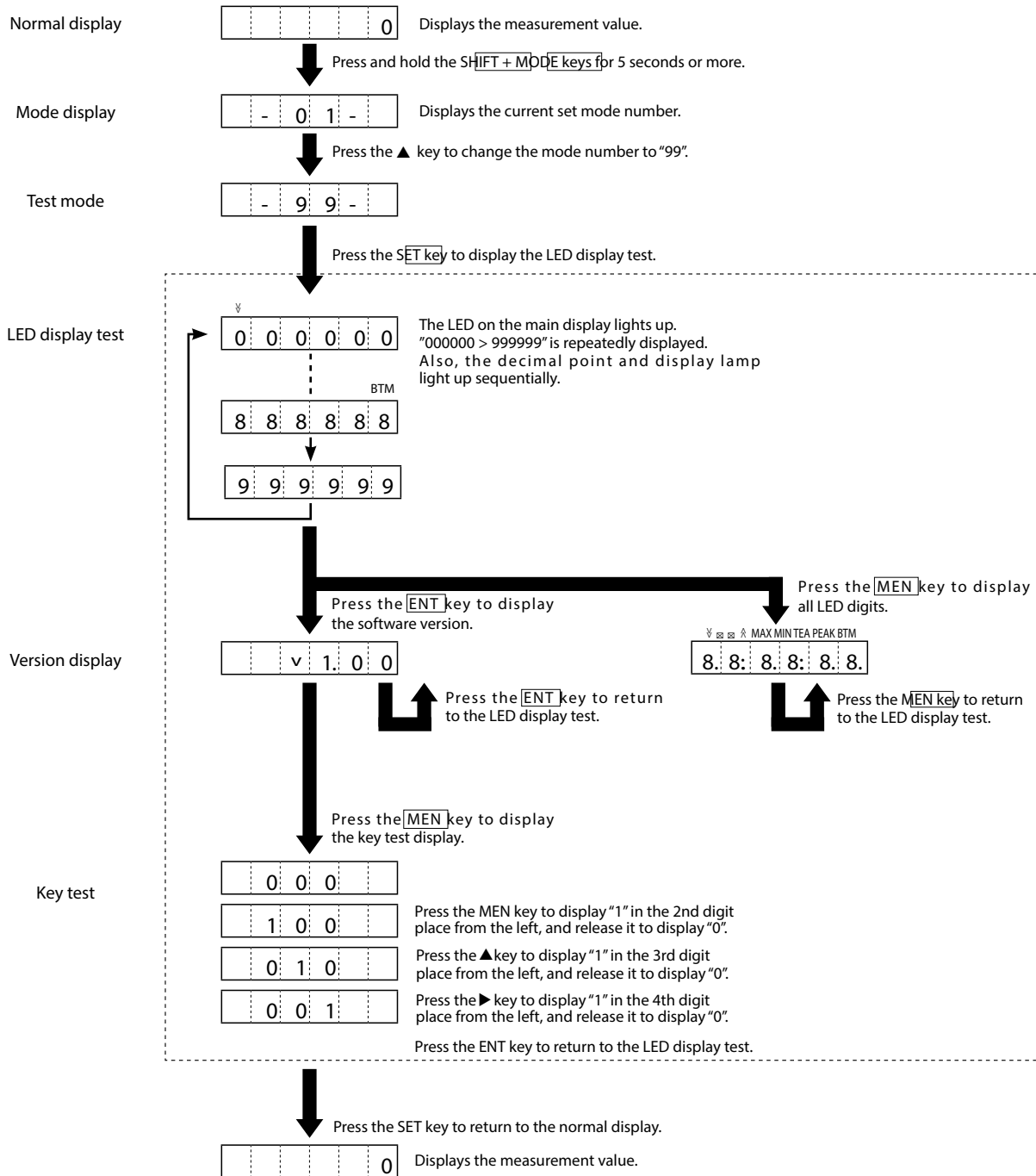

21. Error Display

When an error occurs during operation, the following error codes are displayed. Take appropriate countermeasures based on the displayed code.

	Display	Description	Countermeasure
1		Mode 1, 4: Displayed when the display is overflowed (the display value exceeds the available number of display digits). Mode 2, 3: Displayed when the auto zero function is executed, or the input is less than the minimum revolution speed.	When the input signal becomes within the measurement range (available number of display digits), the measurement value is displayed.
2		Displayed when the input pulse width is 10ms or less in mode 3 (time wide meter mode).	Change the input pulse width to within the measurement range.
3		Displayed when the value is outside the teaching function range (when the input revolution speed is 99,999 or more). *For details, refer to page 7 (detailed teaching function).	Decrease the input revolution speed and execute the teaching function.
4		Displayed when an internal memory error occurs.	Press the ENT (MODE) key to release the error. Note that the setting values of modes, parameters, and functions are initialized.
5		Displayed when the setting value F01 is less than F02, or F03 is less than F04 in the function setting mode.	After the error code is displayed for 2 seconds, the display returns to the previous status before EE-4 is displayed. Change the settings.

22. Parameter List

The following parameters can be set in each mode.

Parameters in mode 1 (Digital Tachometer Mode)

No.	Setting item	Description	Input range	Default value
P1	Pulse count per revolution	Enter the pulse count per revolution for the rotary encoder, etc.	1 - 9999 P/r	1P/r
P2	Setting revolution speed (detection section)	Revolution speed in the detection section	1 - 99999rpm	1000rpm
P3	Value to be displayed (with decimal point)	Actual value to be displayed on the panel in the above revolution speed	0.00001 - 999999rpm	1000rpm
P4	Display cycle	Sets the display update cycle	0.2/0.5/1.0/2.0/5.0/10/15/30/60 sec.	1.0
P5	Auto zero time ^{*1}	Sets the time from when the input pulse is gone to when the display becomes "0".	0.1 - 150 sec.	6.0 sec.
P6	Input filter ^{*2}	Selects a minimum frequency that is larger than the maximum frequency of the input signal. 0.02kHz for the contact input	10/30/100/0.02kHz	10kHz \boxtimes

Parameters in mode 2 (Elapsed Timecounter Mode)

No.	Setting item	Description	Input range	Default value
P1	Pulse count per revolution	Enter the pulse count per revolution for the rotary encoder, etc.	1 - 9999 P/r	1P/r
P2	Setting revolution speed (detection section)	Revolution speed in the detection section	1 - 99999rpm	1000rpm
P3	Value to be displayed (Hour:Minute:Second display system)	Actual value to be displayed on the panel in the above revolution speed	0:00:01 - 9:59:59	10:00 (second display system)
	Value to be displayed (second display system)		0:01 - 999:99	
P4	Display cycle	Sets the display update cycle	0.2/0.5/1.0/2.0/5.0/10/15/30/60 sec.	1 sec.
P5	Auto zero time ^{*1}	Sets the time from when the input pulse is gone to when the display becomes "0".	0.1 - 150 sec.	6 sec.
P6	Input filter ^{*2}	Selects a minimum frequency that is larger than the maximum frequency of the input signal. 0.02kHz for the contact input	10/30/100/0.02kHz	10kHz \boxtimes

Parameters in mode 3 (Time width meter Mode)

No.	Setting item	Description	Input range	Default value
P1	Hour/minute/second and 1/100 second display systems	Selects the time display method.	0:00:00(hour:minute:second display system) / 0:00(1/100 second display system)	1/100 second display system
P2	Measurement section	Selects the measurement time, i.e. during input signal ON or OFF.	0(when OFF)/1(when ON)	1 \boxtimes ON \boxtimes
P3	Auto zero time ^{*1}	Sets the time from when the input pulse is gone to when the display becomes "0".	0.1 - 3600 sec.	3600 sec.
P4	Input filter ^{*2}	Selects a minimum frequency that is larger than the maximum frequency of the input signal.	10/0.02kHz	10kHz \boxtimes

Parameters in mode 4 (Flowmeter Mode)

No.	Setting item	Description	Input range	Default value
P1	Number of blades per revolution	Sets the number of blades per revolution	1 - 99 \boxtimes (1 when the number is unknown)	1
P2	Capacity per sensor blade (cc, l, etc.)	Enter the capacity per blade that the sensor can read.	0.0001 - 99999	1.0
P3	Scaling	Unit coefficient value	0.00000 - 999999	1
P4	Decimal point display	Designates the decimal point position	0.00000 - 00000.0	00000.0
P5	Display cycle	Sets the display update cycle	0.2/0.5/1.0/2.0/5.0/10/15/30/60 sec.	1 sec.
P6	Auto zero time ^{*1}	Sets the time from when the input pulse is gone to when the display becomes "0".	0.1 - 150 sec.	6 sec.
P7	Input filter ^{*2}	Selects a minimum frequency that is larger than the maximum frequency of the input signal. 0.02kHz for the contact input	10/30/100/0.02kHz	10kHz \boxtimes

*1 About the auto zero time

When the input pulse becomes 0Hz during the measurement, and the auto zero time is elapsed, the display is reset to zero.

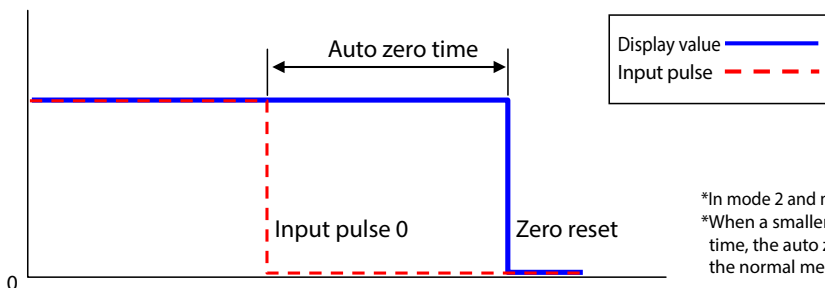

*In mode 2 and mode 3, the zero reset display is "----:--:--".

*When a smaller value than the input pulse cycle is set as the auto zero time, the auto zero function is activated for every pulse, which disables the normal measurement.

*2 Input filter

Set the input filter with the larger value than the input signal frequency.

Example) When the 15kHz signal is input, set the 30kHz filter.

Note) When the duty of the input signal (proportion of the ON time in one cycle) is low, the signal may be attenuated and the pulse may not be received normally even if you set the filter with a larger value than the input frequency. When this occurs, set the filter with an even larger value.

23. Function List

The following functions can be set in each mode.

Function in mode 1 (Digital Tachometer Mode)

No.	Setting item	Description	Input range	Default value
F1	High set point 1 value ^{*1}	Sets the high set point 1 value	000000 - 999999	0
F2	Low set point 1 value ^{*1}	Sets the low set point 1 value	000000 - 999999	0
F3	High set point 2 value ^{*1}	Sets the high set point 2 value	000000 - 999999	0
F4	Low set point 2 value ^{*1}	Sets the low set point 2 value	000000 - 999999	0
F5	Hysteresis of the high and low set point 1 values ^{*1}	Sets the hysteresis of the high and low set point 1 values	0 - 99	0
F6	Judgment output timer at startup ^{*2}	Sets the time when the comparator judgment is output at startup	0 - 99 sec.	0 sec.
F7	Minimum revolution speed	Sets the revolution speed to be displayed as zero	000000 - 999999	0
F8	Frequency of the moving average	Used when variation of the revolution speed is large and a stable display cannot be attained	0(disabled)/1(3 times)/2(10 times)	0(disabled)
F9	Pre-arithmetic function	Promptly performs the deceleration display when the signal is lost	0(disabled)/1(enabled)	0(disabled)

Function setting item in mode 2 (Elapsed Timecounter Mode)

No.	Setting item	Description	Input range	Default value
F1	High set point 1 value ^{*1}	Sets the high set point 1 value (Hour:Minute:Second display system)	0:00:00 - 9:59:59	Second display system
		Sets the high set point 1 value (Second display system)	0:00 - 999:99	0:00
F2	Low set point 1 value ^{*1}	Sets the low set point 1 value (Hour:Minute:Second display system)	0:00:00 - 9:59:59	Second display system
		Sets the low set point 1 value (Second display system)	0:00 - 999:99	0:00
F3	High set point 2 value ^{*1}	Sets the high set point 2 value (Hour:Minute:Second display system)	0:00:00 - 9:59:59	Second display system
		Sets the high set point 2 value (Second display system)	0:00 - 999:99	0:00
F4	Low set point 2 value ^{*1}	Sets the low set point 2 value (Hour:Minute:Second display system)	0:00:00 - 9:59:59	Second display system
		Sets the low set point 2 value (Second display system)	0:00 - 999:99	0:00
F5	Hysteresis of the high and low set point 1 values ^{*1}	Sets the hysteresis of the high and low set point 1 values	0 - 99	0
F6	Judgment output timer at startup ^{*2}	Sets the time when the comparator judgment is output at startup	0 - 99 sec.	0 sec.
F7	Minimum revolution speed	Sets the revolution speed to be displayed as zero	000000 - 999999	0
F8	Frequency of the moving average	Used when variation of the revolution speed is large and a stable display cannot be attained	0(disabled)/1(3 times)/2(10 times)	0(disabled)
F9	Pre-arithmetic function	Promptly performs the deceleration display when the signal is lost	0(disabled)/1(enabled)	0(disabled)

Function setting item in mode 3 (Time width meter Mode)

No.	Setting item	Description	Input range	Default value
F1	High set point 1 value ^{*1}	Sets the high set point 1 value (Hour:Minute:Second display system)	0:00:00 - 9:59:59	Second display system
		Sets the high set point 1 value (Second display system)	0:00 - 999:99	0:00
F2	Low set point 1 value ^{*1}	Sets the low set point 1 value (Hour:Minute:Second display system)	0:00:00 - 9:59:59	Second display system
		Sets the low set point 1 value (Second display system)	0:00 - 999:99	0:00
F3	High set point 2 value ^{*1}	Sets the high set point 2 value (Hour:Minute:Second display system)	0:00:00 - 9:59:59	Second display system
		Sets the high set point 2 value (Second display system)	0:00 - 999:99	0:00
F4	Low set point 2 value ^{*1}	Sets the low set point 2 value (Hour:Minute:Second display system)	0:00:00 - 9:59:59	Second display system
		Sets the low set point 2 value (Second display system)	0:00 - 999:99	0:00
F5	Hysteresis of the high and low set point 1 values ^{*1}	Sets the hysteresis of the high and low set point 1 values	0 - 99	0
F6	Judgment output timer at startup ^{*2}	Sets the time when the comparator judgment is output at startup	0 - 99 sec.	0 sec.

Function in mode 4 (Flowmeter Mode)

No.	Setting item	Description	Input range	Default value
F1	High set point 1 value ^{*1}	Sets the high set point 1 value	000000 - 999999	0
F2	Low set point 1 value ^{*1}	Sets the low set point 1 value	000000 - 999999	0
F3	High set point 2 value ^{*1}	Sets the high set point 2 value	000000 - 999999	0
F4	Low set point 2 value ^{*1}	Sets the low set point 2 value	000000 - 999999	0
F5	Hysteresis of the high and low set point 1 values ^{*1}	Sets the hysteresis of the high and low set point 1 values	0 - 99	0
F6	Judgment output timer at startup ^{*2}	Sets the time when the comparator judgment is output at startup	0 - 99 sec.	0 sec.
F7	Minimum flow (display value)	Sets the revolution speed to be displayed as zero	000000 - 999999	0
F8	Frequency of the moving average	Used when variation of the revolution speed is large and a stable display cannot be attained	0(disabled)/1(3 times)/2(10 times)	0(disabled)
F9	Pre-arithmetic function	Promptly performs the deceleration display when the signal is lost	0(disabled)/1(enabled)	0(disabled)

***1 For details about the high set point 1 and 2 values, as well as the low set point 1 and 2 values, refer to “Comparator Function” on page 17.**

***2 About the judgment output timer at startup**

When you set the value larger than 1 in the function item “F6 Judgment output timer at startup”, the judgment output timer function can be used. After the power is turned on, judgment starts when the judgment output timer setting time has elapsed after the start of measurement.

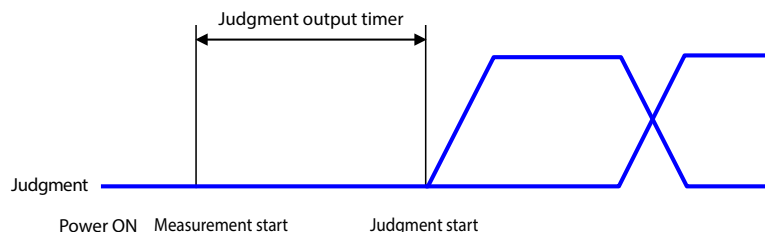

*3 About the minimum revolution speed (minimum flow)

When you set a value larger than 1 in the function item "F7 Minimum revolution speed (minimum flow)", the following functions can be used.

- ☒ In mode 1 and mode 2, the display value is "0" when the measurement revolution speed becomes less than the minimum revolution speed (In mode 2, the display shows "-.-.-.-.") ☒
- ☒ In mode 4, the display value is "0" when the measurement display value becomes less than the minimum flow.

Mode 1: Judgment condition: $(\text{Input frequency}/\text{P1 setting value}) \times 60 \geq \text{Minimum revolution speed}$ ☒ Display value = "0"
 Mode 2: Judgment condition: $(\text{Input frequency}/\text{P1 setting value}) \times 60 \geq \text{Minimum revolution speed}$ ☒ Display value = "-.-.-.-."
 Mode 3: No judgment
 Mode 4: Judgment condition: Display value < Minimum flow ☒ Display value = "0"

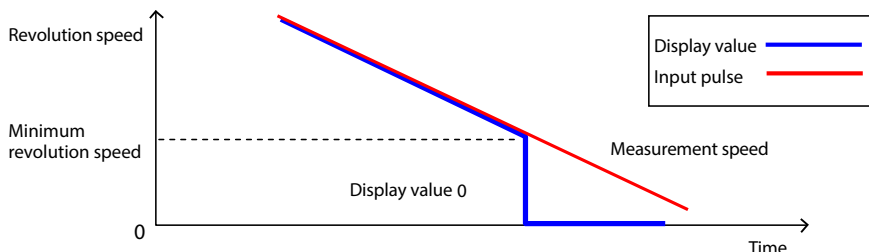

*4 About the frequency of the moving average

When you select values other than "0" in the function item "F8 Frequency of moving average", the frequency of the moving average function can be used. Displays the measurement value per display cycle averaged by the frequency of the moving average.

☒ When the moving average function is not set (F8 setting value "0")

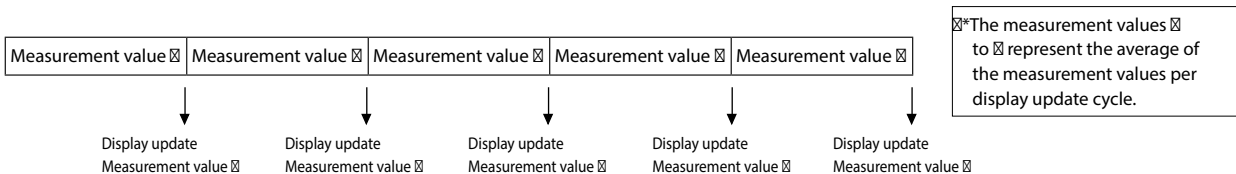

☒ When the moving average function is set (F8 setting value "1", "2")

Displays the measurement value per display cycle averaged by the frequency of the moving average. The figure below shows the relationship between the display update in the F8 setting "0" (moving average: 3 times) and averaging.

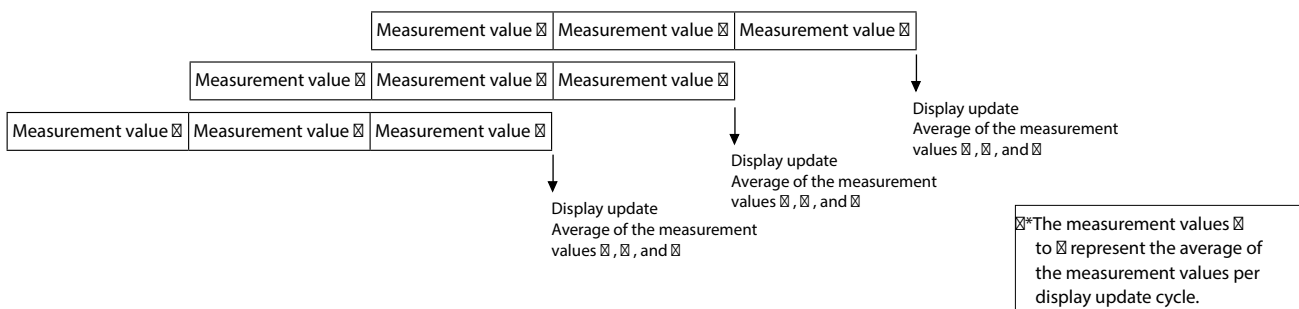

*5 About the pre-arithmetic function

When you select "1" in the function item "F9 Pre-arithmetic function", the pre-arithmetic function can be used. Promptly performs the deceleration display when the input signal is lost.

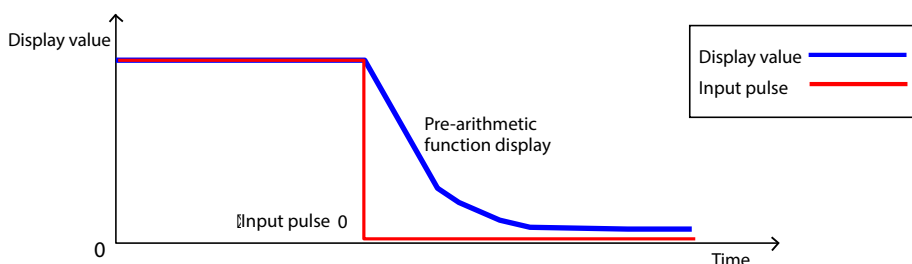

When the auto zero function is activated, the display becomes "0" ("-.-.-.-." in mode 2 and mode 3).

24. Option -FVT/-FVC

When equipped with -FVT/-FVC option, analog signal output (voltage/current) is available according to the displayed data.

1. Specifications for -FVT/-FVC Option

Model	-FVT/-FVC		
Output	Current output	4 20mA	
	Voltage output	0 10V	
		1 5V	
		0 1V	
Load	Output current	below 500Ω	
	Output voltage	above 1kΩ	
Connector (FVC)*	Meter :PCS-E36LMD Attachment : Plug PCS-E36SF Cover PCS-E36LA (Both manufactured by HONDA TSUSHIN KOGYO CO., LTD.)		

*Cables are to be connected by the user.

2. Connection for -FVT/-FVC Option

-FVT Option (Terminal block)

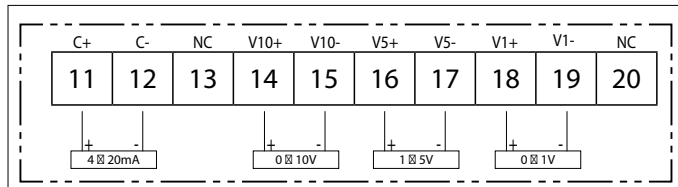

*Select one out of these output options

-FVC Option (Connector)

Code	Pin number		Code
C+	1	19	C-
4 20mA+	2	20	4 20mA-
NC	3	21	NC
NC	4	22	NC
NC	5	23	NC
NC	6	24	NC
NC	7	25	NC
NC	8	26	NC
V10+	9	27	V10-
0 10V+	10	28	0 10V-
NC	11	29	NC
NC	12	30	NC
V5+	13	31	V5-
1 5V+	14	32	1 5V-
NC	15	33	NC
NC	16	34	NC
V1+	17	35	V1-
0 1V+	18	36	0 1V-

*Select one out of these output options

*1 and 2 are interconnected to each other. 9-10, 13-14, 17-18, 19-20, 27-28, 31-32, 35-36 are also interconnected respectively.

Connector numbering

(as the plug is viewed from wire connection side)

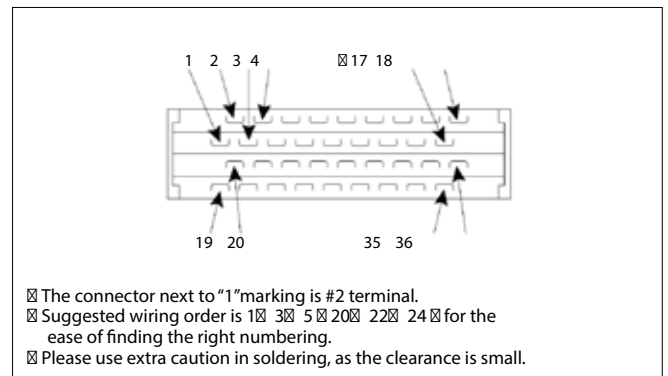

3. -FVT/-FVC Option Setting

When equipped with -FVT/-FVC option, following setting options are enabled from function setting feature.

No.	Setting item	Description	Input range	Default		
F11	Maximum analog signal displayed value	Set the displayed value which corresponds to the maximum value of each analog signal. 4 20 mA Maximum value 20 mA 0 10 V Maximum value 10 V 1 5 V Maximum value 5 V 0 1 V Maximum value 1 V	Mode 1	000000 ~ 99999999	1000	
			Mode 2	Hour:Minute:Second Displayed in Seconds	0:00:00 ~ 9:59:59 000:00 ~ 999:99	Displayed in Seconds 10:00
			Mode 3	Hour:Minute:Second Displayed in Seconds	0:00:00 ~ 0:59:59 000:00 ~ 999:99	Displayed in Seconds 10:00
			Mode 4	00000000 ~ 99999999	1000	
F12	Minimum analog signal displayed value	Set the displayed value which forces the output of the minimum value of each analog signal. 4 20 mA Minimum value 4 mA 0 10 V Minimum value 0 V 1 5 V Minimum value 1 V 0 1 V Minimum value 0 V	Mode 1	00000000 ~ 99999999	1000	
			Mode 2	Hour:Minute:Second Displayed in Seconds	0:00:00 ~ 9:59:59 000:00 ~ 999:99	Displayed in Seconds 10:00
			Mode 3	Hour:Minute:Second Displayed in Seconds	0:00:00 ~ 0:59:59 000:00 ~ 999:99	Displayed in Seconds 10:00
			Mode 4	00000000 ~ 99999999	1000	
F13	Analog signal output timing	Maximum speed when the period is zero.(10ms). When the period is 1, analog signal output is renewed at each display renewal cycle. when the frequency is above 200Hz	0 (Maximum speed) / 1 (In sync with display renewal)	0 (Maximum speed)		
F14	Analog signal output offset	Set the output offset value as the percentage of the output range for each analog signal. 4 20 mA Output range 16mA 0 10 V Output range 10V 1 5 V Output range 4V 0 1 V Output range 1V	-100.00 ~ 100.00	0		

When offset is OFF off set F14 = 0

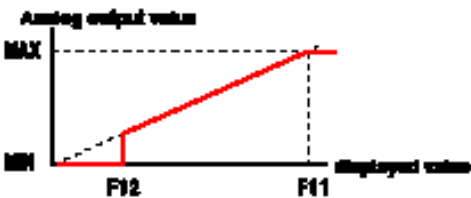

Condition	Analog output value
displayed value > F11 set value	Maximum value 20mA 10V 5V 1V
F12 < displayed value < F11	(Maximum value/ F11) × Measured value for analog output
displayed value < F12 set value	Minimum value 4mA 0V 1V 0V

When offset is ON off set F14 > 0

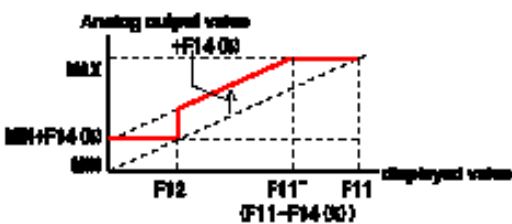

Condition	Analog output value
displayed value > F11	Maximum value 20mA 10V 5V 1V
F12 < displayed value < F11	(Maximum value/ F11) × Measured value for analog output + (Offset value)
displayed value < F12 set value	Minimum value 4mA 0V 1V 0V + (MAX × F14)

F11' is the displayed value when the analog output value, including F14(%) of the output range, is equal to the MAX value.

Example) Assuming the output is 10V, F11= 200, F14 = 10(%), then F11'= 180, therefore the output is 10V when the displayed value is above 180.

When offset is ON off set F14 < 0



Condition	Analog output value
displayed value > F11	Maximum value 20mA 10V 5V 1V
F12 < displayed value < F11	(Maximum value/ F11) × Measured value for analog output - (Offset value)
displayed value < F12 set value	Minimum value 4mA 0V 1V 0V - (Offset value)

The minimum value for MIN-F14(%) in the diagram above is 0mA, in the case of current output (4 20mA)

Example) Assuming the output is 10V, F11= 200, F14 = -10(%), then F11'= 220, therefore the output is 10V when the displayed value is above 220.

The minimum value for MIN-F14(%) in the diagram above is 0mA, in the case of current output (4 20mA)

25. Option -BCD

When equipped with -BCD option, Binary Coded Decimal output is possible

1. Specifications for -BCD Option

Model	-BCD	
NPN Open collector output	Output capacity	30VDC/20mA
	Open collector (NPN) input	
Open collector input	LO input	Load capacity : minimum 5mA 0 ~ 1.5V
	HI input	Leakage current : maximum 0.1mA
Data output	6 digits BCD code	
Decimal point output	DP1 4 1 4 digits after decimal point	
Control output	PLUS	When output data is positive, PLUS turns to LO
	DT OUT	When DATA OUT is HI, output signal is set
	OVR	When displayed value overflows, OVR turns to LO
Control input	HOLD	While HOLD is LO, output data does not renew
	ENABLE	While ENABLE is LO, output has high impedance
Connector	Meter :PCS-E36LMD/ Accessory side: Plug PCS-E36FS Cover PCS-E36LA (Both manufactured by HONDA TSUSHIN KOGYO CO., LTD.)	
Positive-logic-negative-logic available for BCD and decimal point output (opted at Function 10)		

☒ Cable connection is to be done by users.

☒ Timing chart

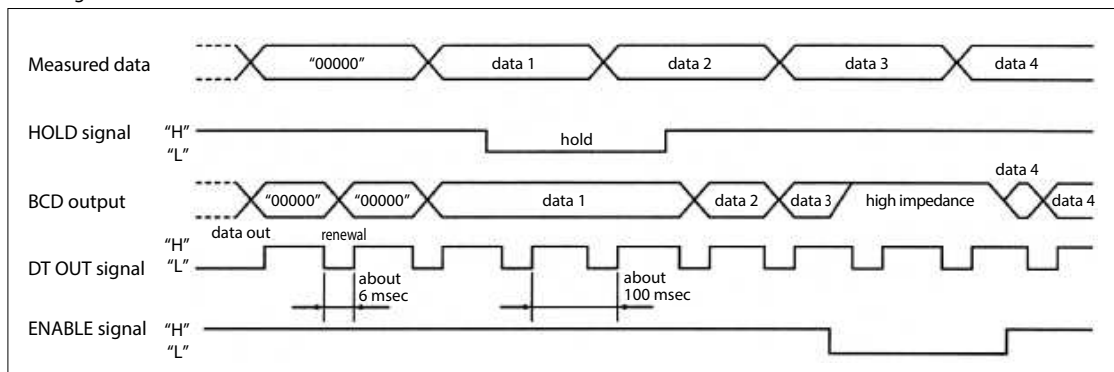

2. Connection for -BCD Option

in/out	Code	Pin number	Code	in/out	
Output	×10 ⁰	1	1	19	1
		2	2	20	2
		4	3	21	4
		8	4	22	8
	×10 ¹	1	5	23	1
		2	6	24	2
		4	7	25	4
		8	8	26	8
	×10 ²	1	9	27	1
		2	10	28	2
		4	11	29	4
		8	12	30	8
	PLUS	13	31	DP1	
	DT OUT	14	32	DP2	
	OVR	15	33	DP3	
Input	HOLD	16	34	DP4	
	ENABLE	17	35	GND	
	GND	18	36	GND	

HOLD input circuit

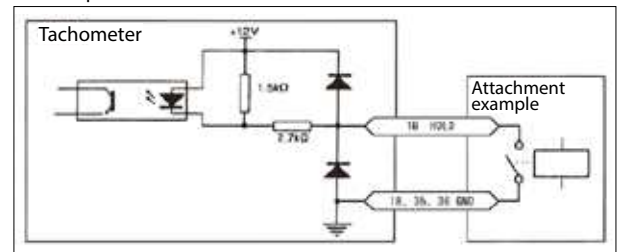

Output circuit

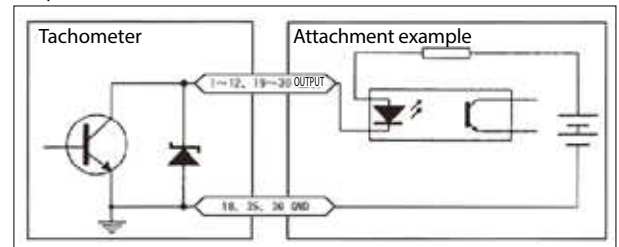

ENABLE input circuit

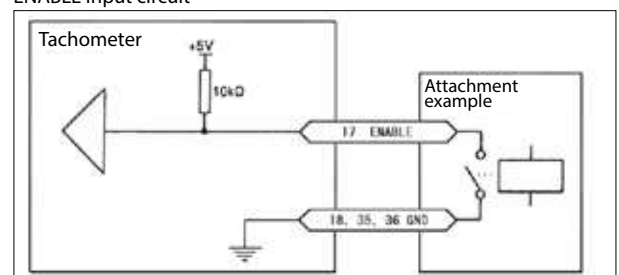

Connector numbering

(as the plug is viewed from wire connection side)

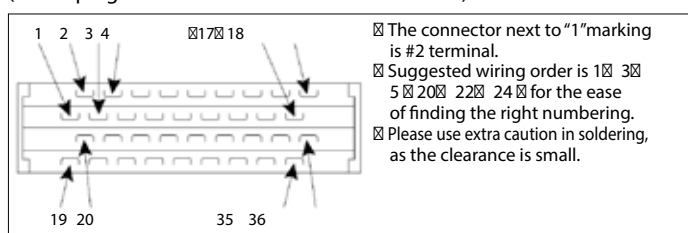

3. -BCD Option Setting

When equipped with -BCD option, following setting options are enabled from function setting feature.

No.	Setting item	Description	Input range	Default
F10	BCD output logic	Set as 0 for negative logic, set as 1 for positive logic (decimal point output)	<input type="checkbox"/> _ 0 _ <input type="checkbox"/> (Negative logic)/ <input type="checkbox"/> _ 1 _ <input type="checkbox"/> (Positive logic)	Negative logic

- F10 sets positive/negative logic for BCD output, Decimal point output, PLUS, OVR.
- Logic for DT OUT, HOLD, ENABLE signals cannot be set.

BCD output display specifications

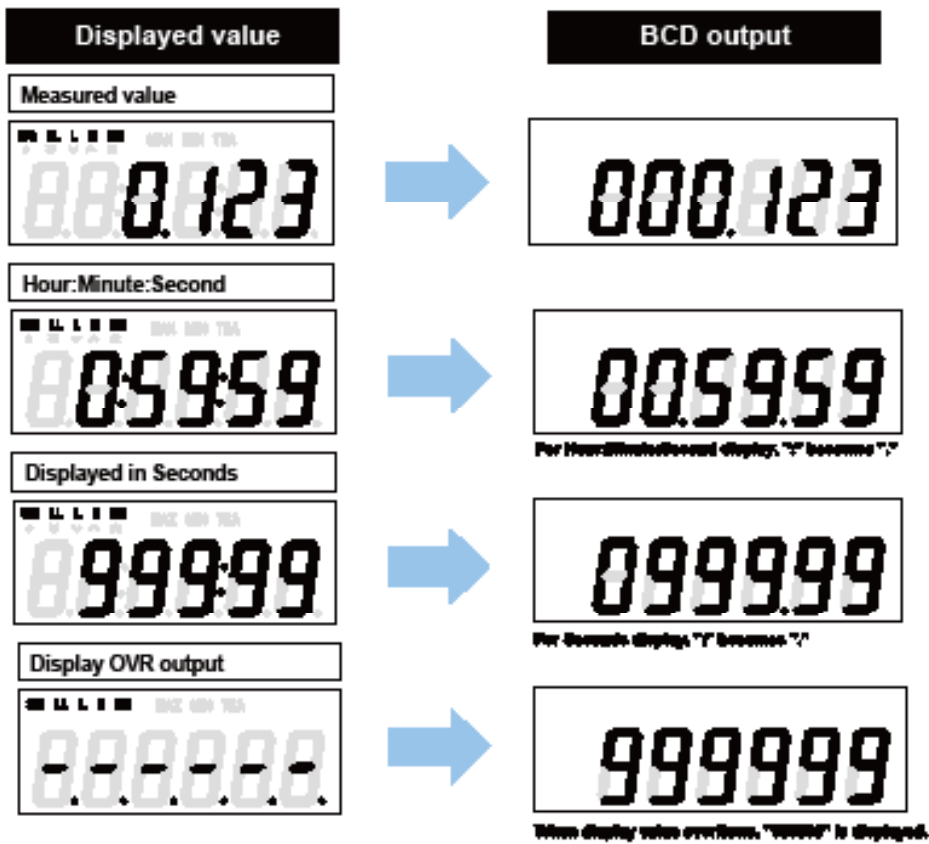

26. Option -TRT

When equipped with -TRT option, comparison result output is possible.(LL,L,GO,H,HH,ZERO)

1. -TRT option specifications

Model	-TRT	
Output capacity	30VDC 20mA	
Residual voltage	Less than 1.5V	
Output signal	Measured value \geq Low set point 2 value	LL signal is ON
	Measured value \geq Low set point 1 value	L signal is ON
	Low set point 1 value \geq Measured value \geq High set point 1 value	GO signal is ON
	High set point 1 value \geq Measured value	H signal is ON
	High set point 2 value \geq Measured value	HH signal is ON
Measured value = 0	ZERO signal is ON	
Output is insulated from internal circuitry		
Negative logic open collector output		

2. -TRT option connection

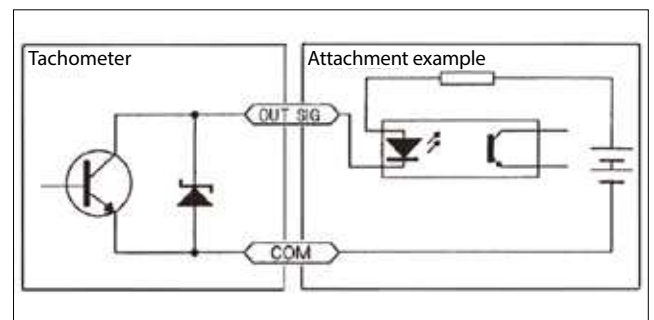
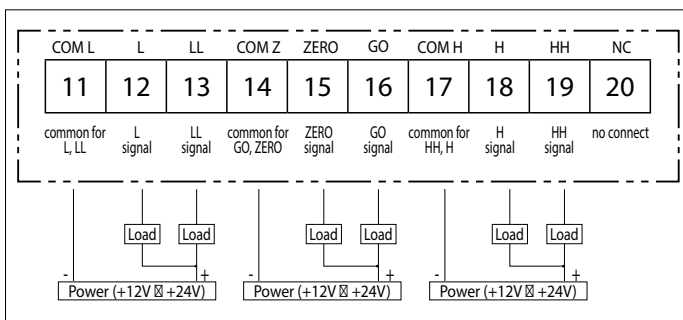

27. Option -CPT

When equipped with -CPT option, comparison result output is possible.(L,GO,H)

1. -CPT option specifications

Model	-CPT	
Output contact	1C	
Rated load	Resistance load	250VAC 5A 100K operations 30VDC 5A 100K operations
	Induction load $\cos\phi = 0.4$	250VAC 2.5A 100K operations 30VDC 2.5A 100K operations
Output signal	Measured value \geq Low set point 1 value	L signal is ON
	Low set point 1 value \geq Measured value \geq High set point 1 value	GO signal is ON
	High set point 1 value \geq Measured value	H signal is ON

2. -CPT option connection

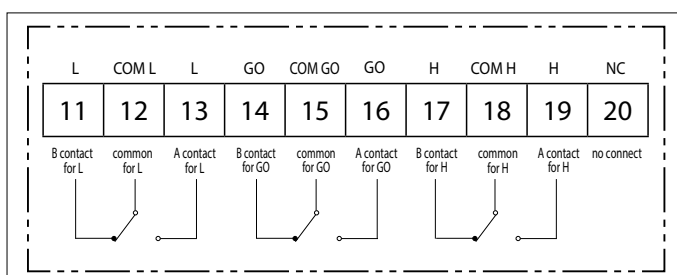

Output circuit

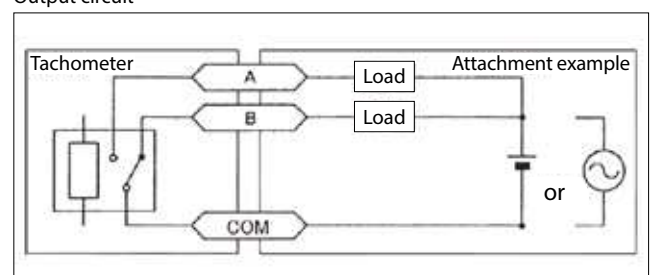

28. DT-501X / DT-501F series model list

This operation manual is applicable to following models.

Input spec	Model		Option 1		Option 2	
	AC power type	DC power type				
Standard input	DT-501XA-FVT	DT-501XD-FVT	-FVT	Voltage output	-	
	DT-501XA-FVT-BCD	DT-501XD-FVT-BCD			-BCD	BCD output
	DT-501XA-TRT	DT-501XD-TRT	-TRT	Transistor output	-	
	DT-501XA-TRT-FVC	DT-501XD-TRT-FVC			-FVC	Voltage output
	DT-501XA-TRT-BCD	DT-501XD-TRT-BCD			-BCD	BCD output
	DT-501XA-CPT	DT-501XD-CPT	-CPT	Relay output	-	
	DT-501XA-CPT-FVC	DT-501XD-CPT-FVC			-FVC	Voltage output
	DT-501XA-CPT-BCD	DT-501XD-CPT-BCD			-BCD	BCD output
DT-501XA-FVC	DT-501XD-FVC	-			Voltage output	
DT-501XA-BCD	DT-501XD-BCD	-	-	-BCD	BCD output	
Differential input	DT-501FA-FVT	-	-FVT	Voltage output	-	
	DT-501FA-FVT-BCD				-BCD	BCD output
	DT-501FA-TRT		-TRT	Transistor output	-	
	DT-501FA-TRT-FVC				-FVC	Voltage output
	DT-501FA-TRT-BCD				-BCD	BCD output
	DT-501FA-CPT		-CPT	Relay output	-	
	DT-501FA-CPT-FVC				-FVC	Voltage output
	DT-501FA-CPT-BCD				-BCD	BCD output
DT-501FA-FVC	-	Voltage output				
DT-501FA-BCD	-	-	-BCD	BCD output		

*For the detail of standard input and differential input, please refer to following pages.☒

Standard input : P5 Input Specifications

Differential input : P6 Input Specifications